



*User's Guide*

---

## EM3 AEM<sup>®</sup> Monitor

---



*User's Guide*

---

# AEM<sup>®</sup> Monitor

---

REF EM3

**ENCISION<sup>®</sup>**



**Manufactured by:**

Encision Inc.  
6797 Winchester Circle  
Boulder, Colorado 80301-3513



Ph: 303-444-2600  
Fax: 303-444-2693



**Authorized Representative:**

MDSS GmbH  
Schiffgraben 41  
30175 Hannover, Germany

**US Patents**

# 5,312,401 and 5,688,269.

**International Patents**

Japan Patent # 2,509,081  
Canada Patent # 2,112,817  
European Patent Convention # 0596909  
Australia Patent # 667322

**Trademark acknowledgments**

Encision® and AEM® are registered trademarks of Encision Inc.  
All other referenced trademarks are owned by their respective owners.



ETL LISTED  
MEDICAL ELECTRICAL  
EQUIPMENT  
CONFORMS TO UL STD 60601-1

Printed in USA

Part Number: 04195-001 Rev. B 2013/03  
© 2013 Encision Inc. All rights reserved.

# Table of Contents

---

## Foreword

Indications for Use .....	i
Contraindications.....	i
Conventions Used in This Manual.....	ii
Warnings and Cautions.....	iii
Explosion, Fire, and Shock Hazards .....	iii
General Electrosurgical Hazards.....	iv
Active Accessories and AEM Monitor .....	v
Electromagnetic Compatibility (EMC) Hazards .....	vi
Symbol Definitions .....	vii

<b>A</b>	<b>Accessories .....</b>	<b>A-1</b>
----------	--------------------------	------------

## 1 Introduction

Unpacking the AEM Monitoring System .....	1-1
Attaching the Power Cord Retainer Bracket.....	1-2
Active Electrode Monitoring .....	1-3
Monopolar Electrosurgery .....	1-3
Bipolar Electrosurgery .....	1-3

## 2 Controls, Indicators, and Receptacles

Covers.....	2-1
Front Panel .....	2-2
Rear Panel .....	2-4

## 3 System Setup

Setup for Monopolar Applications.....	3-2
Maximum Power Settings for Electrosurgical Generators .....	3-5
Instrument Functional Test (Monopolar) .....	3-6
Setup for End Point Monitoring System (Bipolar Applications) .....	3-7
End Point Monitoring System Check .....	3-9

## 4 System Maintenance and Troubleshooting

System Maintenance.....	4-1
Monopolar System Check.....	4-1
Electrical Inspection of the End Point Monitoring Display .....	4-4
Mechanical Inspection .....	4-4
Cleaning the AEM Monitor .....	4-5
Storing the AEM Monitor.....	4-5
Troubleshooting – AEM Monitor (Monopolar) .....	4-6
Troubleshooting – End Point Monitor (Bipolar) .....	4-9

## 5 Principles of Operation

Theory of Operation – AEM Monitoring System (Monopolar) .....	5-1
Theory of Operation - End Point Monitoring System (Bipolar) .....	5-4

<b>6</b>	<b>Surgical Use</b>	
	Before Surgery.....	6-1
	Monopolar Surgery .....	6-2
	Bipolar Surgery.....	6-3
	General Precautions.....	6-4
	Return Electrode .....	6-4
	Active Accessories .....	6-4
	Operating Room Troubleshooting .....	6-6
	Correcting Setup Faults.....	6-6
	Responding to Monitor Alarms .....	6-6
	Preparing the AEM Monitor for Reuse.....	6-8
<b>7</b>	<b>Technical Specifications</b>	
	Operating Modes - AEM Monitoring.....	7-1
	Functional Characteristics.....	7-2
	Indicators and Alert Functions .....	7-3
	Setup Fault Indicators .....	7-3
	Operative Fault Indicators .....	7-3
	Status Indicators.....	7-3
	Bipolar Current Indicator.....	7-3
	Connectors and Cables .....	7-4
	Maximum Generator Voltage .....	7-5
	Electrical Characteristics .....	7-5
	Dimensions and Weight .....	7-5
	Environmental Characteristics .....	7-5
	Standards and IEC Classifications.....	7-6
	Compatible Products .....	7-10
	Electrosurgical Generators .....	7-10
	Return Electrodes.....	7-10
	Active Electrodes .....	7-10
<b>8</b>	<b>Replacement Parts and Service</b>	
	Replacement Parts and Procedures .....	8-1
	Customer Replaceable Parts .....	8-1
	Replacing the Fuse .....	8-1
	Returning the AEM Monitor .....	8-2
	Obtaining a Return Material Authorization Number .....	8-2
	Cleaning the Monitor .....	8-2
	Shipping the Monitor .....	8-2
	Service Center .....	8-2
	Limited Warranty.....	8-3

**Service Center**

Encision Inc.  
 6797 Winchester Circle  
 Boulder, Colorado 80301-3513 USA  
  
 (303) 444-2600  
 www.encision.com

# Foreword

This manual and the equipment it describes are for use only by qualified medical professionals trained in the particular technique and surgical procedure to be performed. This manual is intended as a guide for servicing the AEM Monitor, including its setup and operation. It is not intended to be a general reference about the use of electrocautery either in general application or in laparoscopic procedures.

## Indications for Use

The Encision AEM Monitoring System is an accessory for use with electrocautery generators and electrodes that is designed to safely deliver electrocautery energy and to prevent injury caused by insulation failure and capacitive coupling.

The AEM Monitoring System consists of two distinct functions:

- Active electrode monitoring is intended to control stray monopolar energy caused by insulation failure and capacitive coupling in surgical instruments on the shaft of the instrument.
- End point monitoring is intended to aid the surgeon in determining the end point of bipolar electrocautery desiccation.

## Contraindications

There are no known contraindications for use of the AEM Monitor.

### WARNING

Prior to using the AEM System, read and review all instructions in this manual and instructions for use for all instruments and accessories to be used.

### CAUTION

Federal (USA) law restricts this device to sale by or on the order of a physician.

The AEM Monitor is designed to safely deliver electrocautery energy and to prevent injury caused by insulation failure and capacitive coupling. The Encision AEM Monitor is not intended to test for insulation damage on laparoscopic instruments. Do not attempt to use this system as an instrument inspection tool.

## Conventions Used in this Manual

**WARNING**

Indicates a hazardous condition that can result in serious injury or death.

**CAUTION**

Indicates a condition that can cause a problem with the device.

**NOTICE**

Indicates an operating tip or maintenance suggestion.

## Warnings and Cautions

Refer to the manual of your electrosurgical generator (ESU) for applications information including warnings and precautions regarding its use before proceeding further.

### Explosion, Fire, and Shock Hazards

#### WARNING

Explosion Hazard. Do not use electrosurgery in the presence of flammable anesthetics.

Fire/Explosion Hazard. The following substances will contribute to increased fire and explosion hazards in the operating room:

- Flammable substances (such as alcohol based skin prepping agents and tinctures).
- Naturally occurring flammable gases which may accumulate in body cavities such as the bowel.
- Oxygen agents (such as nitrous oxide [N<sub>2</sub>O] atmospheres).

The sparking and heating associated with electrosurgery can provide an ignition source. Observe fire precautions at all times. When using electrosurgery in the same room with any of these substances or gases, prevent their accumulation or pooling under surgical drapes, or within the area where electrosurgery is performed.

Fire Hazard. Do not use extension cords.

Fire Hazard. For continued protection against fire hazard replace fuses only with the same type and rating.

Fire Hazard. Electrosurgical accessories that are activated or hot from use can cause a fire. Do not place them near or touching flammable materials (such as gauze or surgical drapes).

Electric Shock Hazard. Connect the monitor power cord to a properly grounded receptacle. Do not use power strip plug adapters.

Electric Shock Hazard. Ensure that all accessories, cords, and adapters are correctly connected and that no metal is exposed.

Electric Shock Hazard. Do not connect a wet power cord to the AEM Monitor or to the wall receptacle.

Electric Shock Hazard. Always unplug the AEM Monitor before cleaning.

Electric Shock Hazard. Do not open the AEM Monitor cover.



## General Electrosurgical Hazards

### WARNING

Any electrosurgical procedure is safest if moderate control settings are used along with minimum activation times. Prolonged activations without the electrode in contact with the tissue should be avoided.

Confirm proper electrosurgical power setting before proceeding with surgery. Use the lowest power setting that achieves the desired surgical effect.

In order to lessen the possibility of creating unintended burns, activate the electrosurgical generator only when the active electrode is near or touching the target tissue.

The safe use of monopolar electrosurgery requires proper placement of the patient return electrode. To avoid electrosurgical burns beneath the patient return electrode, follow all directions on the product package for proper return electrode placement and use.

In some circumstances, potential exists for alternate site burns at points of skin contact (e.g., between the arm and the side of the body). This occurs when electrosurgical current seeks a path to the patient return electrode that includes a skin to skin contact point. Current passing through small skin to skin contact points is concentrated and may cause a burn. This is true for earth referenced and isolated output generators.

To reduce the potential for alternate site skin burns, do one or more of the following:

- Avoid skin to skin contact points, such as fingers touching leg, when positioning the patient.
- Place two to three inches of dry gauze between contact points to ensure that contact does not occur.
- Position the patient return electrode to provide a direct current route between the surgical site and the return electrode which avoids skin-to-skin contact.
- In addition, place patient return electrodes according to the manufacturer's instructions.

Keep electrical connections dry while in use to prevent potential conduction of High Frequency (HF) current to the user.

Potentially hazardous conditions may exist when accessories of similar connector types are intermixed. Be certain that accessories are appropriate for the type of electrosurgical generator output used and the intended application.

While using electrosurgery, the patient should not be allowed to come into direct contact with grounded metal objects (e.g., surgical table frame, instrument table, etc.). If this is not possible during certain procedures (e.g., those in which noninsulated head frames are used), use extreme caution to maximize patient safety:

- Use the lowest power setting that achieves the desired effect.
- Place the patient return electrode as close to the surgical site as possible.
- Place dry gauze between the patient and the grounded object if possible.
- Continually monitor the contact point(s).

## Active Accessories and AEM Monitor

### WARNING

These devices have been specifically designed for use in electrosurgery. Do not use for other procedures.

Do not wrap accessory cords around metal objects. Wrapping cords around metal objects may induce currents that could lead to shocks, fires, or injury.

The electrode tip may remain hot enough to cause burns after the electrosurgical current is deactivated.

When not in use, place accessories in a clean, dry, nonconductive and highly visible area not touching the patient. Inadvertent contact with the patient may result in burns.

Inadvertent activation or movement of the activated electrode tip outside the field of vision may result in injury to the patient. Use these instruments only under conditions that ensure adequate visualization.

Localized burns to the patient or physician may come from electrical currents carried through conductive objects (such as cannulas or scopes). Electrical current may be generated in conductive objects by direct contact with the active accessory cable being in close proximity to the conductive object.

Ensure that the insulation of conventional, nonshielded disposable and reusable laparoscopic instrumentation is intact. Compromised insulation of nonshielded instruments may lead to shocks or burns to the patient or surgical personnel.

When using laparoscopic instrumentation with metal cannulas, the potential exists for abdominal wall burns to occur in the event of direct electrode tip contact to the cannula.

Refer to the cannula manufacturer's instructions before inserting the electrode into the cannula. To avoid damaging the electrode or injuring the patient, insert and withdraw them carefully.

Inspect cords for breaks, cracks, nicks or other damage before every use. Verify that end of life indicators are not present. If any of these are present, do not use. Failure to observe this precaution may result in injury or electrical shock to the patient or operating personnel.

Damaged external insulation on instruments AND incorrect setup of the AEM Monitor may result in a risk of unintended patient burn. Do not use product having damaged insulation.

When an alert is presented by the AEM Monitor, discontinue use of the electrosurgical current immediately. Find the cause of the alert and correct it before continuing use.

Damaged internal insulation of the instrument, or loss of shield continuity, may cause AEM Monitor alarms. For maximum patient safety, discontinue use of the instrument if this occurs.

A single AEM instrument must be the sole conductor of energy to tissue. Do not conduct energy by touching an AEM instrument to a second instrument contacting tissue. The second device will not be protected from capacitive coupling and insulation failure.

Good operating room practice suggests that connections of accessories to electrosurgical generators be made only while the generator is off or in standby mode.

Use the AEM Monitor only if the Power On Self Test (POST) has been properly completed (see Section 3 for details). Otherwise, AEM functions may not be operative.

**CAUTION**

Read the instructions, warnings, and cautions provided with the AEM Monitoring System accessories before using. Their specific instructions are not included in this manual.

AEM Monitoring will not function without the use of a dual pad return electrode and an electrosurgical generator equipped with contact quality monitoring patient safety technology.

Limit power setting to 80 watts or lower as specified in the power settings tables (see Section 3). Higher settings may result in spurious insulation failure alarms and/or insulation breakdown. Refer to instrument instructions for use for other limits.

## **Electromagnetic Compatibility (EMC) Hazards**

For EMC specification tables, refer to Section 7, *Technical Specifications*.

**CAUTION**











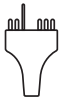











Use of accessories, transducers, and cables other than those specified, with the exception of transducers and cables sold by the manufacturer of the Equipment or System as replacement parts for internal components, may result in increased Emissions or decreased Immunity of the Equipment or System.

The AEM Monitor should not be used adjacent to or stacked with other equipment except as specified herein. If adjacent or stacked use is necessary, the equipment should be observed to verify normal operation in the configuration in which it will be used.

Follow the electrosurgery unit manufacturer's instructions as far as locating equipment within the operating room to diminish or eliminate radio frequency electrical interference with other electronic equipment.

Medical electrical equipment needs special precautions regarding EMC and needs to be installed and put into service according to the EMC information provided in the accompanying documents. Portable and mobile RF communications equipment can affect medical electrical equipment.

## Symbol Definitions

	Type CF equipment with defibrillator protection		Hand Control
	Output is floating (isolated) with respect to ground		Foot Control
	High Voltage		Instrument Cord Connection Fault
	POST Reset		Return Electrode
	Remote Display Jack		Bipolar Accessory
	Equipotential Ground		Volume Control (End Point Monitoring System only)
~	Alternating Current (AC)		Caution
	Federal (USA) law restricts this device to sale by or on the order of a physician.		Manufacturer
	Consult instructions for use		Manufacture Date
	Catalog Number		Temperature Limitation
	Serial Number		Humidity Limitation
	Refer to instruction manual		Fuse Rating

This page intentionally left blank.

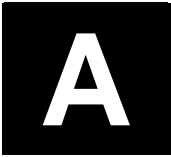

## Accessories

Use the AEM Monitor with the following Encision accessories. Separate Instructions for Use are provided with the accessories.

- EM3 Monopolar ESU Adapter
- End Point Monitor Remote Display
- AEM Cord
- EM3 Bipolar ESU Adapter
- Bipolar Instrument Cords
- AEM Handle Assembly
- Inserts, Reusable and Disposable
- Disposable Sheath
- Fixed Tip Electrodes, Reusable and Disposable
- Suction Irrigation Electrodes, Reusable and Disposable
- AC Input Cord, Hospital Grade 120v, 15' (4.6 m) or 220-240v, 10' (3 m)

Or Encision approved compatible accessories.

### **CAUTION**

Use of other accessories or cables may result in increased EMC emissions or decreased immunity.

Contact Customer Service at (303) 444-2600 for current catalog or go to [www.encision.com](http://www.encision.com).

This page intentionally left blank.

---

# 1

## Introduction

Congratulations on your purchase of the AEM Monitor. Active electrode monitoring technology continuously monitors and dynamically manages stray current during monopolar electrosurgery.

### CAUTION

The Encision AEM System is designed to safely deliver electrosurgical energy and to prevent injury caused by insulation failure and capacitive coupling. The AEM system is not intended to test for insulation damage on laparoscopic instruments. Do not attempt to use this system as an instrument inspection tool.

### The AEM Monitor consists of two distinct functions:

- **Active Electrode Monitoring** – Intended to control stray monopolar energy caused by insulation failure and capacitive coupling in surgical instruments on the shaft of the instrument.
- **End Point Monitoring** – Intended to aid the surgeon in determining the end point of bipolar electrosurgical desiccation.

## Unpacking the AEM Monitoring System

The AEM system is shipped in one carton. Store this carton so that it will be available if the need for service arises.

Carefully unpack the carton. Check to ensure you received the following parts. If any of these parts are missing, contact Customer Service immediately.

- **EM3 AEM Monitor**
- **Power Cord**
- **Power Cord Retainer Bracket** (see installation instructions in this section)
- **Quick Setup Guide**
- **User's Guide** (CD version or paper copy)

Contact Encision Customer Service at (303) 444-2600 to arrange for repair or replacement of any parts damaged from shipping.



## Attaching the Power Cord Retainer Bracket

This optional accessory keeps the power cord firmly connected to the AEM Monitor. The power cord must be attached to the monitor prior to installing the bracket. After installation of the retainer bracket, the bracket must be removed before the power cord can be disconnected from the monitor.

1. Attach the power cord supplied with the AEM Monitor to the power entry module on the rear panel. Ensure that the power cord is fully seated into the module.
2. Position the retainer bracket over the power cord plug and align the thumb screw over the mounting hole (located above the power entry module).
3. Tighten the thumb screw by hand. A phillips-head screwdriver may be used to secure the thumb screw.

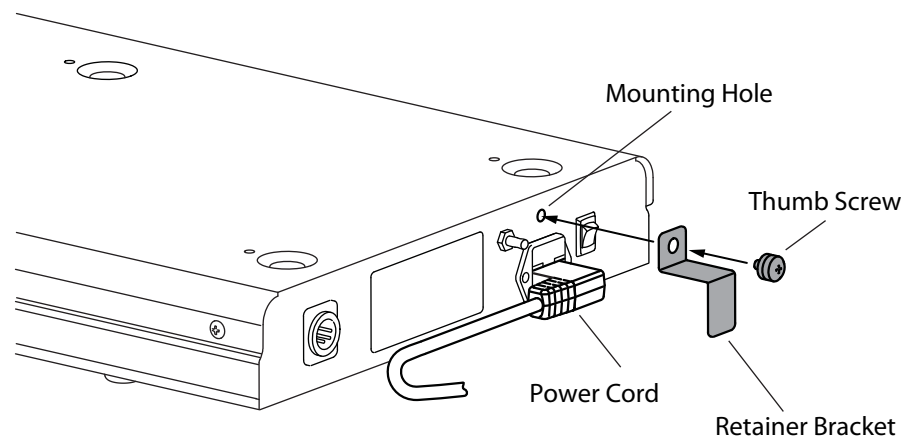

## **Active Electrode Monitoring**

Active electrode monitoring technology can eliminate the risk of stray electrical energy caused by insulation failure and capacitive coupling and thus helps to prevent unintended internal burn injury to the patient. AEM instruments direct electro-surgical energy where the surgeon desires, while continuously monitoring the current flow to prevent stray electro-surgical energy from insulation failure or capacitive coupling.

AEM instruments have a patented, multi-layered design with a built-in shield, much like the third wire ground in standard electrical cords. The shield in these instruments is referenced back to a monitor at the electro-surgical generator. In the event of a harmful level of stray electrical energy, the monitor shuts down the power; ensuring patient safety. The AEM system protects against capacitive coupling by providing a neutral return path for capacitively coupled electrical current. Capacitively coupled energy is continually drained away from the instrument and away from the patient through the protective shield built into all AEM instruments.

## **Monopolar Electrosurgery**

In monopolar electrosurgery, the surgical instrument contains only the active electrode. A separate return electrode to the patient recovers the current that passes through the patient and returns it safely to the electro-surgical generator.

Monopolar electrosurgery is used for most surgical procedures that require sparking to tissue, such as those in which tissue must be cut or coagulated over wide areas.

## **Bipolar Electrosurgery**

In bipolar electrosurgery, the surgical instrument includes both electrodes. A patient return electrode is not used. Current flows between the two electrodes and through the tissue contacted by the instrument, heating that tissue.

In bipolar electrosurgery, control is needed to ensure the correct degree of heating.

This page intentionally left blank.

# 2

## Controls, Indicators, and Receptacles

This section describes the AEM Monitor features. For definitions of symbols, refer to *Symbol Definitions* in the Foreword Section.

### Covers

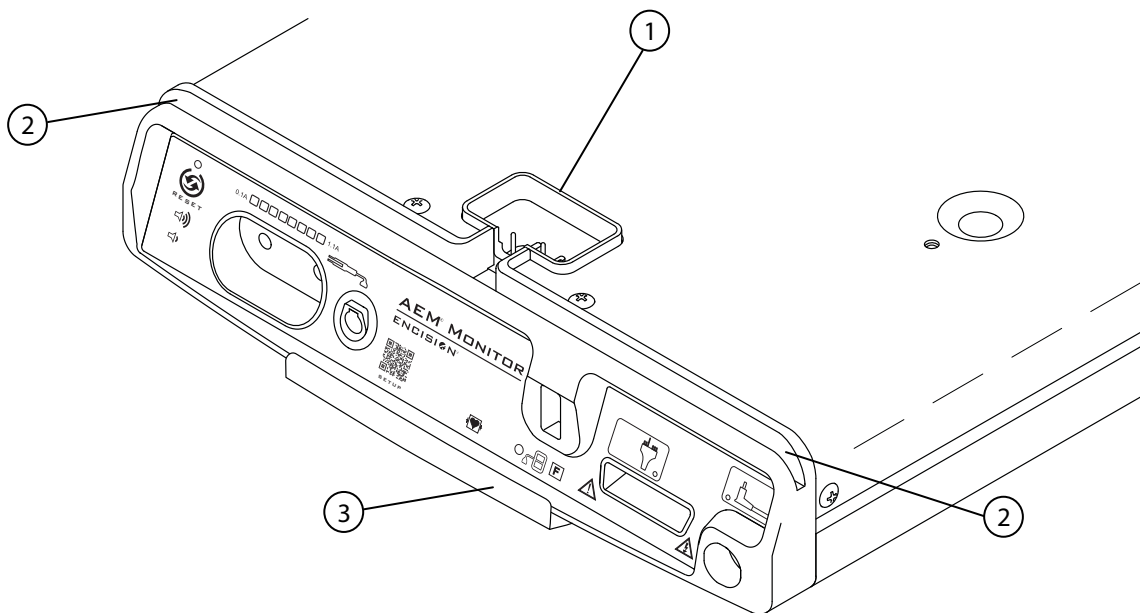

- ① **Monopolar ESU Adapter Receptacle**  
Connect the Monopolar Adapter to this receptacle and to the electro-surgical generator (ESU). See Section 3 for system setup.
- ② **Cable Channel**  
Route the Monopolar Adapter cable through this channel to either side of the monitor (optional).
- ③ **Tray**  
When extended, the tray provides a convenient place to store the Monopolar Adapter when not connected to the ESU. The tray also has a recess for storing the *Quick Setup Guide*.

## Front Panel

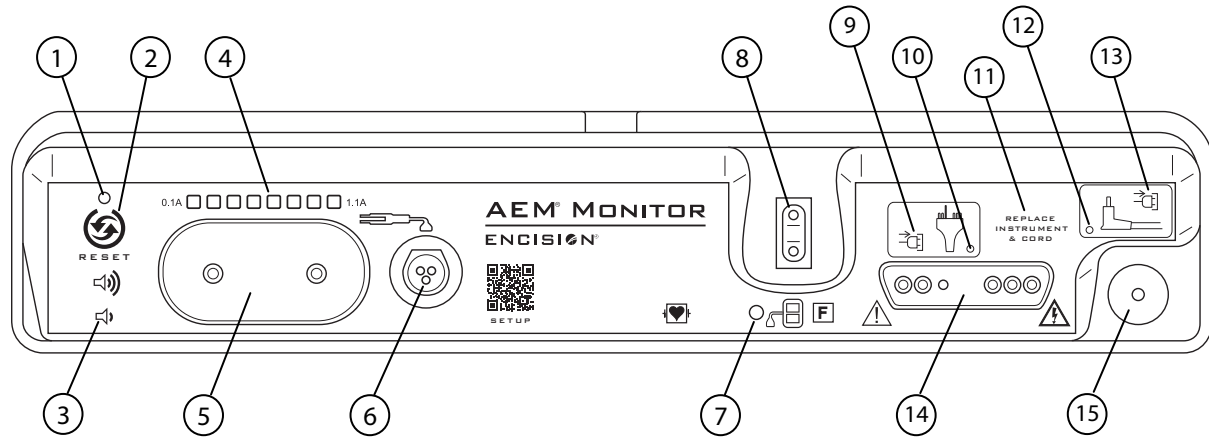

- ① **POST (Power On Self Test) Reset Indicator**  
Illuminates green when the monitor has successfully completed POST.
- ② **POST (Power On Self Test) Reset Button**  
Press this button to reset the monitor and initiate the POST function.
- ③ **Volume Control Buttons**  
Press these buttons to increase or decrease the volume level for the bipolar clicks generated by the monitor. *The volume can be completely muted.*
- ④ **Bipolar Current Indicator**  
Indicates the level of current flowing during bipolar instrument activation.
- ⑤ **Bipolar Instrument Receptacle**  
Connect the bipolar instrument to this receptacle.
- ⑥ **Bipolar ESU Adapter Receptacle**  
Connect the Bipolar Adapter to this receptacle and to the electrosurgical generator. See Section 3 for system setup.
- ⑦ **Return Electrode Indicator**
  - Illuminates green when the return electrode is properly connected and ready for use.
  - Illuminates amber if the return electrode is of the wrong type or is not connected.
- ⑧ **Return Electrode Receptacle**  
Connect the return electrode to this receptacle.

- ⑨ **Instrument Cord Connection Fault Indicator** (hand control)  
Illuminates solid amber until a hand control instrument and cord are connected. If the instrument cord is disconnected, the indicator illuminates blinking amber for 30 seconds before returning to a solid amber illumination. See Section 6 for information on correcting fault conditions.
- ⑩ **Hand Control Instrument Indicator**
- Illuminates solid amber until a cord, hand control instrument, and return electrode are properly connected.
  - Illuminates solid green when a hand control instrument and a return electrode are properly connected and ready for use.
  - Illuminates blinking green when a hand control instrument is activated.
- Illuminates solid amber if a hand control instrument insulation fault or cord connection fault is detected.
- ⑪ **Instrument Insulation Fault Indicator**  
The text "Replace Instrument & Cord" illuminates solid amber (for approximately 30 seconds) if an instrument insulation fault is detected for a hand control or foot control instrument. See Section 6 for information on correcting fault conditions.
- ⑫ **Foot Control Instrument Indicator**
- Illuminates solid amber until a cord, foot control instrument, and return electrode are properly connected.
  - Illuminates solid green when a foot control instrument and a return electrode are properly connected and ready for use.
  - Illuminates blinking green when a foot control instrument is activated.
- Illuminates solid amber if a foot control instrument insulation fault or cord connection fault is detected.
- ⑬ **Instrument Cord Connection Fault Indicator** (foot control)  
Illuminates solid amber until a foot control instrument and cord are connected. If the instrument cord is disconnected, the indicator illuminates blinking amber for 30 seconds before returning to a solid amber illumination. See Section 6 for information on correcting fault conditions.
- ⑭ **Hand Control Instrument Receptacle**  
Connect the hand control instrument cord to this receptacle.
- ⑮ **Foot Control Instrument Receptacle**  
Connect the foot control instrument cord to this receptacle.

## Rear Panel

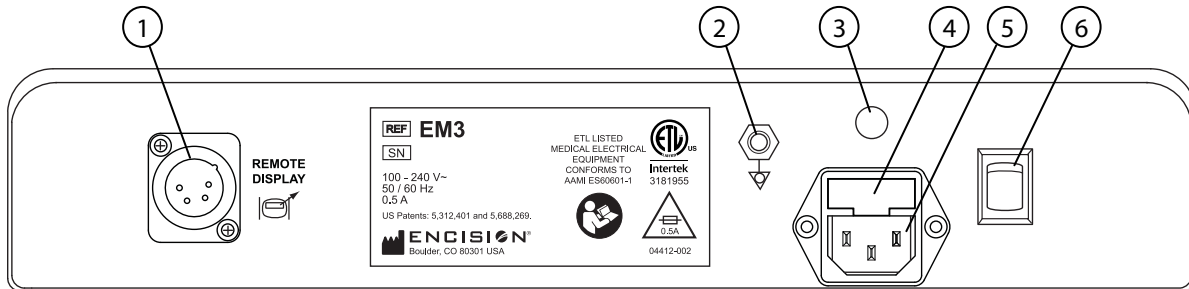

- ① **End Point Monitor Remote Display Receptacle**  
Connect the End Point Monitor Remote Display (EMR) to this receptacle.
- ② **Equipotential Pin**  
Connect an equipotential conductor to this pin as required by country electrical standards (optional).
- ③ **Retainer Bracket Mounting Hole**  
Mount the power cord retainer bracket using this hole. See Section 1 for installation instructions.
- ④ **Fuse Drawer**  
The external fuses are located in this drawer. See Section 8 for instructions on replacing blown fuses.
- ⑤ **Power Entry Module**  
Connect the power cord provided with the AEM Monitor to this receptacle.
- ⑥ **Power Switch**  
Power the AEM Monitor on or off with this switch.

# 3

## System Setup

This section describes how to set up the AEM Monitoring System, turn it on, connect accessories, and perform system checks.

### **WARNING**

Fire Hazard. Do not use extension cords.

Electric Shock Hazard. Connect the power cord to a properly grounded receptacle. Do not use power plug adapters.

Electric Shock Hazard. Do not connect wet accessories to the monitor. Ensure that accessories and adapters are correctly connected and that no metal is exposed.

Electric Shock Hazard. Do not attempt to connect or disconnect any cable during power activation.

Inspect accessories and cords for breaks, cracks, nicks or other damage before every use. Verify that end of life indicators are not present. If any of these are present, do not use. Failure to observe this precaution may result in injury or electrical shock to the patient or operating personnel.

### **NOTICE**

If you are familiar with the EM3 AEM Monitoring System, refer to the *Quick Setup Guide* for system connections and troubleshooting in the operating suite. The *Quick Setup Guide* can be stored in the Tray located at the front of the Monitor.



## Setup for Monopolar Applications

1. Connect the power cord supplied with the AEM Monitor to the power entry module on the rear panel. Ensure that the power cord is fully seated into the module. If the optional Power Cord Retainer Bracket will be used, install the retainer bracket before proceeding with system setup (see *Attaching the Power Cord Retainer Bracket* in Section 1).
2. Connect the Monopolar ESU Adapter to the AEM Monitor using the receptacle on the top of the monitor. Route the adapter cable to either side of the monitor using the cable channel (optional).

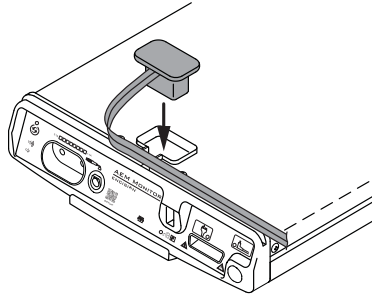

3. Place the AEM Monitor on a cart or attach it to a boom system.
4. Place the electrosurgical generator (ESU) on top of the monitor or in close proximity to the monitor to allow for connection of the Monopolar Adapter.
5. Connect the Monopolar Adapter to your ESU. The adapter plugs into the return electrode receptacle and a hand control accessory receptacle of the ESU. For some ESUs, the adapter may also plug into a foot control accessory receptacle. After properly connecting the adapter, a secondary hand control accessory receptacle on the ESU may be accessible for use.

### WARNING

Electrosurgical generators shown in this section have been tested for use with the EM3 AEM Monitor. Use of an untested ESU may result in an inoperative active electrode monitoring system. See Section 7 for a complete list of compatible ESUs.

### NOTICE

When using the Force Triad ESU, the monopolar hand control connector of the adapter may be disconnected to allow usage of an instrument without AEM technology. The AEM foot control instrument is still available.

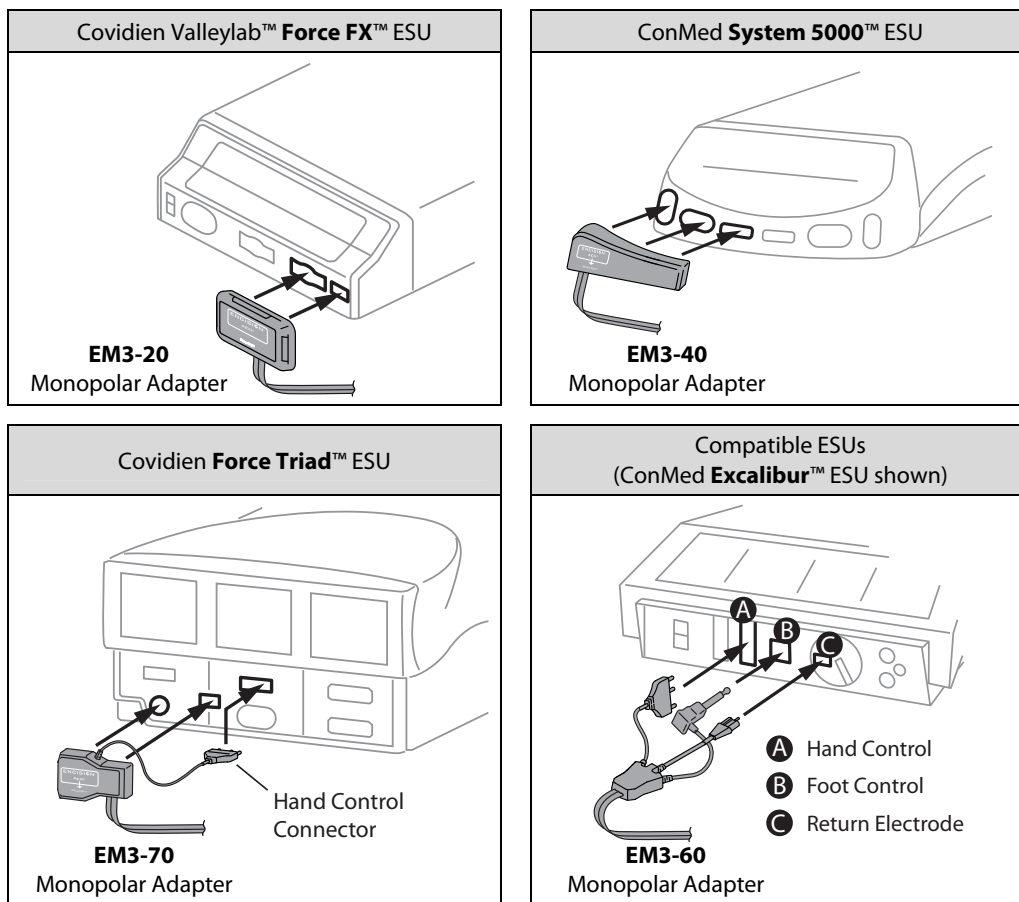

6. Connect an equipotential conductor to the pin on the monitor rear panel (as required by country electrical standards).
7. Connect the monitor power cord to a wall receptacle with the proper voltage.

**CAUTION**

Connect the power cord to a wall outlet having the correct voltage. Otherwise product damage may result.

**Self-Check (Power On Self Test – POST)**

8. Turn on the AEM Monitor. The system completes an automatic self-check (POST). Encision recommends that this self-check be run before beginning each surgical procedure. If the monitor power is left on between procedures, press the Reset button to initiate the POST function. During POST, all of the visual indicators illuminate and two beeps are heard. If this is not the case, see Section 4 *System Maintenance and Troubleshooting*.

**WARNING**

Do not use the AEM Monitor unless the system properly completes the automatic self-check. Otherwise, AEM functions may not be operative.

## Monopolar Accessory Connections to the AEM Monitor

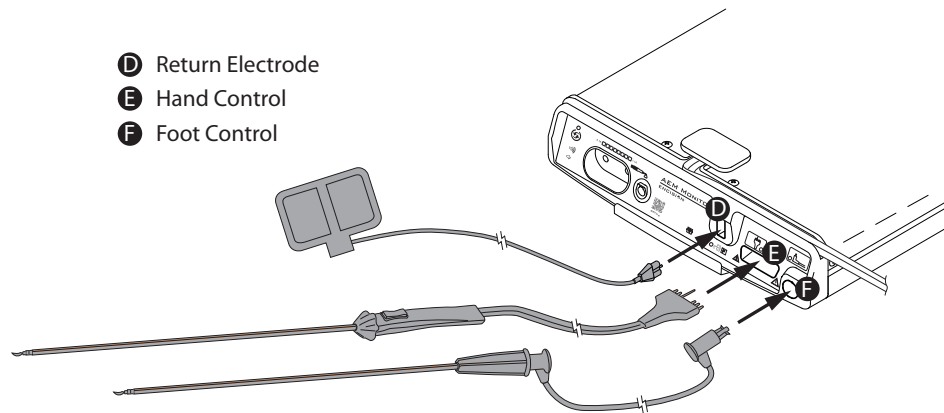

9. Connect the return electrode to the receptacle on the AEM Monitor.

### CAUTION

When using the Universal Monopolar Adapter (EM3-60), ensure that the return electrode is connected to the AEM Monitor and not to the electrosurgical generator. Incorrect connection of the return electrode results in an improper setup condition and the Return Electrode indicator illuminates amber.

10. Verify that the Return Electrode indicator on the AEM Monitor illuminates green. If the indicator continues to illuminate amber, see *Responding to Monitor Alarms* in Section 6.
11. Connect the AEM instrument to the monitor. When using a foot controlled instrument, connect the AEM Cord with the AEM instrument to the Foot Control Instrument receptacle. When using a hand controlled instrument, connect the instrument cord to the Hand Control Instrument receptacle.
12. Verify that the appropriate Instrument indicator illuminates green. If the indicator illuminates amber after connecting the instrument, see *Responding to Monitor Alarms* in Section 6.

### CAUTION

If an Instrument indicator illuminates green when an instrument is not connected, see *Troubleshooting* in Section 4.

13. Turn on the electrosurgical generator, enabling its contact quality monitoring system. It should be in its normal operating state.

### WARNING

Confirm proper power settings before proceeding with surgery. Use the lowest power setting possible for the minimum time necessary to achieve the desired surgical effect.

### CAUTION

Limit power setting to 80 watts or lower as specified in the following power settings tables. Higher settings may result in spurious insulation failure alarms and/or insulation breakdown. Refer to instrument instructions for use for other limits.

14. After successful completion of these steps, the AEM Monitor is ready for use. Encision recommends that a Monopolar System Check be performed before first surgical use. See *System Maintenance* in Section 4.

## Maximum Power Settings for Electrosurgical Generators

Refer to the following tables for maximum power settings of electrosurgical generators used with the EM3 AEM Monitoring System.

Maximum Power Settings for <b>Force FX</b> ESU (W)		
Mode	Foot Control Instrument	Hand Control Instrument
Low Cut	80	80
Pure Cut	80	80
Blend Cut	80	80
Low Coag	80	80
Med Coag	80	45
High Coag	80	80

Maximum Power Settings for <b>System 5000</b> ESU (W)		
Mode	Foot Control Instrument	Hand Control Instrument
Pure Cut	80	80
Blend 1 Cut	80	80
Blend 2 Cut	80	80
Blend 3 Cut	80	80
Coag Spray	80	80
Coag Standard	80	80
Coag Pinpoint	80	80

Maximum Power Settings for <b>Force Triad</b> ESU (W)		
Mode	Foot Control Instrument	Hand Control Instrument
Pure Cut	80	80
Blend Cut	80	80
Fulgurate Coag	80	70
Spray Coag	80	70

Maximum Power Settings for <b>Excalibur</b> ESU (W)		
Mode	Foot Control Instrument	Hand Control Instrument
Pure Cut	80	30
Blend Cut	80	35
Standard Coag	75	40
Spray Coag	60	35

## Instrument Functional Test (Monopolar)

This optional test, performed before surgery begins, verifies proper function and integrity of instruments. The test verifies that the AEM instrument's internal insulation is in good condition and can be expected to perform without fault conditions during surgery.

1. Apply the return electrode to the patient.
2. Set the electrosurgical generator to "coag spray" or "coag fulgurate" (the highest voltage mode depending upon the generator) and set the power level to the maximum power per the previous tables.
3. Next, in the sterile field:
  - Connect the instrument to the AEM Monitoring System following the setup instructions in this section.

### **WARNING**

Ensure that the instrument tip does not touch any other object.

- Activate the instrument using the foot switch or hand control for approximately 3 seconds.
  - Verify that the power indicator on the generator illuminates and that there are no AEM Monitor alarms.
  - Repeat this test on each AEM instrument.
4. Change the ESU power setting to the desired level.
  5. Do not return any instrument giving a fault condition to the tray, but instead discard it or isolate it for further study. Record the type of AEM Monitor alarm as "Instrument Insulation Fault" or "Instrument Cord Connection Fault".

### **NOTICE**

In the case of an Instrument Cord Connection Fault, the fault may be in the cord itself or in the cord's electrical connection with the instrument.

## Setup for End Point Monitoring System (Bipolar Applications)

**NOTICE**

If you are using the Encision End Point Monitor Remote Display (EMR), mount the display near the video monitor or at another location in the view of the operating room staff.

1. Attach the power cord supplied with the AEM Monitor to the power entry module on the rear panel. Ensure that the power cord is fully seated into the module. If the optional Power Cord Retainer Bracket will be used, install the retainer bracket before proceeding with system setup (see *Attaching the Power Cord Retainer Bracket* in Section 1).
2. Attach the End Point Monitor Remote Display to the receptacle on the rear of the AEM Monitor (optional).
3. Place the AEM Monitor on a cart or attach it to a boom system.
4. Place the electrosurgical generator (ESU) on top of the monitor or in close proximity to the monitor to allow for connection of the Bipolar ESU Adapter.
5. Connect the AEM Monitor power cord to a wall receptacle with the proper voltage.

**CAUTION**

Connect the power cord to a wall outlet having the correct voltage. Otherwise product damage may result.

### Self-Check (Power On Self Test – POST)

6. Turn on the AEM Monitor. The system completes an automatic self-check (POST). Encision recommends that this self-check be run before beginning each surgical procedure. If the monitor power is left on between procedures, press the Reset button to initiate the POST function. During POST, all of the visual indicators illuminate and two beeps are heard. If this is not the case, see Section 4 *System Maintenance and Troubleshooting*.

**WARNING**

Do not use the AEM Monitor unless the system properly completes the automatic self-check. Otherwise, monitor functions may not be operative.

7. Connect the Bipolar ESU Adapter into the receptacle on the AEM Monitor and the bipolar output receptacle of the electro-surgical generator.

**NOTICE**

The release tab of the monitor plug end must be facing up before inserting into the receptacle.

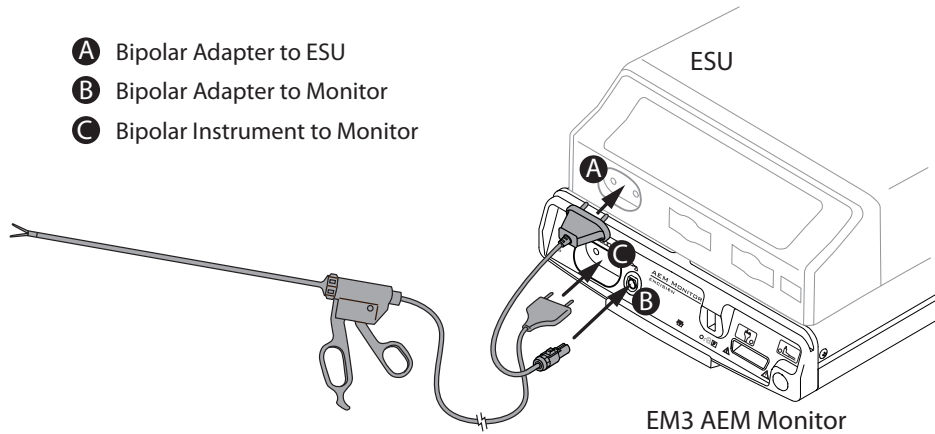

**WARNING**

Electric Shock Hazard. Do not activate the generator bipolar output when the Bipolar Adapter is connected to the generator, but not connected to the AEM Monitor. Accessible pins of the adapter may lead to shock or burns to surgical personnel.

Electric Shock Hazard. Do not connect wet accessories to the generator. Ensure that accessories and adapters are correctly connected and that no metal is exposed.

Inspect accessories and cords for breaks, cracks, nicks or other damage before every use. Verify that end of life indicators are not present. If any of these are present, do not use. Failure to observe this precaution may result in injury or electrical shock to the patient or operating personnel.

8. Prepare the surgical instrument to be used for the procedure. Connect one end of the bipolar instrument cord to the instrument and the other end to the Bipolar Instrument receptacle on the AEM Monitor.
9. Adjust the volume of the clicks that indicate bipolar current flow using the Volume Control buttons on the front panel of the monitor.

**CAUTION**

The End Point Monitor activation clicks when an accessory is active. Do not turn the volume down below an audible level.

10. Turn on the electro-surgical generator. It should be in its normal operating state.
11. Adjust the bipolar output mode and power setting on the electro-surgical generator.

**WARNING**

Confirm proper power settings before proceeding with surgery. Use the lowest power setting possible for the minimum time necessary to achieve the desired surgical effect.

12. After successful completion of these steps, the system is ready for operation. During operation, the Bipolar Current Indicator and the End Point Monitor Remote Display illuminate, indicating the current flowing between the instrument's tines.

**WARNING**

Do not attempt to connect or disconnect any cable during power activation.

## End Point Monitoring System Check

The response of the End Point Monitor may be tested during use.

When performing this check for the first time with a particular bipolar generator, start at a low power setting. Then increase the power setting to obtain a mid-scale illumination of the bar-graph. This test ensures that all three components (cord, bipolar instrument and End Point Monitor) are functional.

1. Set the generator at 5 to 10 watts (depending upon the generator characteristics).
2. Touch the tines of the instrument together. There should be a smooth registration of the current on the Bipolar Current indicator. The clicking will also change its rate in correspondence with the current.



This page intentionally left blank.

---

# 4

## System Maintenance and Troubleshooting

This section gives instructions for performing periodic system tests and for troubleshooting system malfunctions.

### CAUTION

Refer all servicing to qualified personnel.

### NOTICE

Removal of the monitor cover will void the AEM Monitor warranty.

### System Maintenance

Encision recommends that the AEM Monitor be tested and inspected by qualified service personnel on a minimum yearly basis using the following procedures. If the AEM Monitor fails any of these tests or inspections, refer to the Troubleshooting guides later in this section or contact the Encision Service Center.

### Monopolar System Check

The following is a quick test of the AEM Monitoring System. A failure on any of the following tests should be resolved before using the system.

#### Power On Self Test Function (POST)

1. POST is activated when the power is switched on. While power to the AEM Monitor is on, POST may be initiated by pressing the Reset button. During POST, all of the visual indicators illuminate. At the end of a successful POST, two beeps are heard and the POST Reset indicator illuminates.

#### Return Electrode Connect and Disconnect

### CAUTION

AEM Monitoring will not function without the use of dual pad patient return electrodes and an electrosurgical generator equipped with contact quality monitoring patient safety technology.

2. Verify the following:
  - The Return Electrode indicator illuminates amber.
  - The Hand Control Instrument and Foot Control Instrument indicators illuminate amber.
3. Connect a return electrode to the AEM Monitor.
4. Verify that the Return Electrode indicator illuminates green.
5. Disconnect the return electrode from the AEM Monitor. Verify that the Return Electrode indicator illuminates amber and that the Monitor alarm sounds a dual tone.
6. Reconnect the return electrode to the AEM Monitor. Verify that the Return Electrode indicator illuminates green.

#### **AEM Cord Connect and Disconnect**

7. Connect a foot control instrument (using an AEM Cord) or hand control instrument to the AEM Monitor. Verify that the following occurs:
  - The Foot Control Instrument or Hand Control Instrument indicator illuminates green.
  - The corresponding Instrument Cord Connection Fault indicator is not illuminated.
8. Disconnect the foot control instrument from the AEM Cord or the hand control instrument from the AEM Monitor. Verify that the following occurs:
  - The Foot Control Instrument or Hand Control Instrument indicator illuminates amber.
  - The corresponding Instrument Cord Connection Fault indicator illuminates blinking amber for approximately 30 seconds.
  - The Monitor alarm sounds a dual tone.
9. Reconnect the foot control instrument to the AEM Cord or the hand control instrument to the AEM Monitor. Verify that the following occurs:
  - The Foot Control Instrument or Hand Control Instrument indicator illuminates green.
  - The corresponding Instrument Cord Connection Fault indicator extinguishes.

## Active Electrode Spark to Shield Connector

10. Setup – Set up the AEM Monitor with the electrosurgical generator in the normal manner. Connect a return electrode to the Return Electrode receptacle of the Monitor, ensuring that the electrosurgical generator's contact quality monitor is satisfied.

### NOTICE

It may be necessary to add approximately 10 ohms of resistance between the dual pads of the return electrode to satisfy the ESU's contact quality monitor.

Connect a foot control instrument cord (with no instrument connected) to the Foot Control Instrument receptacle of the Monitor. Use a test lead with alligator clips to short together the two contacts of the exposed cord end. Insert an electrosurgical pencil electrode tip into the cord end until it makes contact with the active conductor. Connect one end of an additional test lead with alligator clips to one of the contacts of the cord end, leaving the other end free.

11. Verify that the following occurs:
  - All AEM Monitor fault indicators are extinguished.
  - The Monitor Foot Control Instrument indicator illuminates green.
  - The electrosurgical generator, with the contact quality monitoring system enabled, is in the normal operating state.
12. Set the electrosurgical generator to 20 Watts in the standard coagulation mode. (For the ConMed 5000, set the power to 35 Watts in the standard coagulation mode.)
13. Test – Activate the coag output and carefully move the free alligator clip toward the pencil electrode tip until an arc is seen.

### WARNING

Use care to avoid contact with any exposed metal while the electrosurgical generator is activated.

14. Verify that the following occurs:
  - There is a visible spark at the active electrode.
  - The AEM Monitor Foot Control Instrument indicator illuminates solid amber for 10 seconds.
  - The AEM Monitor text "Replace Instrument & Cord" illuminates solid amber for 30 seconds.
  - The AEM Monitor generates an audio alert of 3 bursts of 3 beeps each.

## Electrical Inspection of the End Point Monitor Display

1. Use a Bipolar Adapter to connect the AEM Monitor to a compatible electrosurgical generator with a continuously adjustable output.
2. Connect the End Point Monitor to the AEM Monitor.
3. Connect a noninductive load resistor (between 50 ohms and 200 ohms) and a reference ammeter in series to the Bipolar Instrument receptacle of the AEM Monitor.

The reference ammeter should have a true RMS response, a bandwidth of at least 10 MHz, and an accuracy of 1%.

4. Agreement between the End Point Monitor and the reference meter should be within 20% of display with currents between 600 mA and 1000 mA.

## Mechanical Inspection

Visually inspect the following items on the AEM Monitoring System and the End Point Monitor. If any of these items appear damaged during the visual inspection, contact the Encision Service Center.

- Insulation of wiring and cables
- Connectors and cables are fully seated
- All hardware is securely fastened
- Monopolar Adapter cable and plug
- Monopolar Adapter receptacle and pins
- Instrument receptacles, sockets, and pins on front panel
- Front panel keypad buttons and LED indicators
- Power switch
- Power entry module

## Cleaning the AEM Monitor

### WARNING

Electric Shock Hazard. Always unplug the AEM Monitor before cleaning.

Clean monitor when needed.

1. Turn off the AEM Monitor.
2. Disconnect all accessories.
3. Follow the procedures approved by your institution or use a validated infection control procedure.
4. Use a mild cleaning solution (100:1 water to mild detergent, by mass) or disinfectant and a damp cloth to thoroughly wipe all outside surfaces and the power cord.

### CAUTION

Do not allow fluids to enter the chassis.

Do not clean the AEM Monitor with abrasive cleaning or disinfectant compounds, solvents, or other materials that could scratch the panels or damage the unit.

Do not steam sterilize the AEM Monitor.

## Storing the AEM Monitor

The AEM Monitor should be stored within these parameters:

- Temperature: -13 to 158° F (-25 to 70° C)
- Humidity: 15% to 95% relative, non-condensing

If you store the AEM Monitor at a temperature that is outside its normal operating range of 59 to 104° F (15 to 40° C), allow one hour for the monitor to reach room temperature before use.

## Troubleshooting – AEM Monitor (Monopolar)

Situation	Possible Cause	Recommended Action
The Power On Self Test function (POST) did not take place when power was turned ON. <b>All</b> indicators are not on, and no beeps are heard.	Disconnected power cord, faulty wall receptacle, or faulty power cord.	Remove the power cord retainer bracket and check the power cord connections (monitor and wall receptacle). Connect the power cord to a functional wall receptacle. If necessary replace the power cord. Re-install the power cord retainer bracket.
	Fuse drawer is open or fuses are blown.	Turn off the AEM Monitor and unplug the unit from the wall receptacle. Open the fuse drawer. Check the fuses and replace, if necessary, with approved fuses. Reinstall the fuse drawer.
	Malfunctioning power entry module or connections.	Inspect the pins of the power entry module. If faulty, contact Encision Service Center.  If the above steps have failed, return the AEM Monitor for service.
The self test function (POST) did not take place when power was turned on.	PCBA malfunction.	Press the Reset button. If POST does not initiate, turn the power switch off for 30 seconds, and then turn on. If the problem persists, return the AEM Monitor for service.
One or both of the <b>Cord Connection Fault</b> indicators illuminate amber even though a cord and instrument are connected.	Poor connection of the cord to the instrument or AEM Monitor.	Disconnect the instrument from the AEM cord or handpiece and reconnect it. Repeat this step between the AEM cord or handpiece and the AEM Monitor.
	Faulty AEM cord or instrument.	Replace the AEM cord and instrument.  If the above steps have failed, return the AEM Monitor for service.

Situation	Possible Cause	Recommended Action
Electrosurgical generator remains in alarm state.	Improper return electrode.	Must use a dual-pad return electrode. Verify that the return electrode connector has a pin projecting from the end.
<b>Return Electrode</b> indicator illuminates amber.	The return electrode lead from the Universal Monopolar Adapter (EM3-60 only) is connected to the monitor.	The return electrode lead from the Universal Monopolar Adapter (EM3-60) must be connected to the electrosurgical generator.
	Dual Electrode pin is not being detected.	Remove the return electrode connector from the AEM Monitor and reinsert fully. If the Return Electrode indicator illuminates green, unit is OK. If not, wiggle the return electrode connector from side to side. If the indicator does not illuminate green, return the AEM Monitor for service.
Electrosurgical generator remains in alarm state. Both <b>Return Electrode</b> and <b>Cord Connection Fault</b> indicators illuminate amber.	See possible causes for both "Return Electrode indicator illuminates amber" and "Cord Connection Fault indicators illuminate amber."	See recommended action for both "Return Electrode fault indicator illuminates amber" and "Cord Connection Fault indicators illuminate amber."
Electrosurgical generator remains in alarm state.	Electrosurgical generator in alert state.	Reset the contact quality monitor on the electrosurgical generator.
<b>POST Reset</b> indicator is on and all fault indicators are off.	Dual pad open or short circuited.	Install dual pad so that correct resistance is seen by the electrosurgical generator.
	Poor connection in return electrode circuit.	Disconnect and reconnect return electrode connection to the AEM Monitor. Disconnect and reconnect the Monopolar Adapter to the electrosurgical generator (if using the EM3-60 Universal Monopolar Adapter, disconnect and reconnect the return electrode lead to the generator).
	Malfunctioning electrosurgical generator.	Plug the return electrode connector directly into the electrosurgical generator. If the electrosurgical generator still shows an alarm status, replace the electrosurgical generator.
		If the above steps have failed, return the AEM Monitor for service.



Situation	Possible Cause	Recommended Action
<p>AEM Monitor does not detect operative fault.</p> <p>The text <b>“Replace Instrument &amp; Cord”</b> remains off during <b>Insulation Fault</b> condition.</p>	<p>Arc/Short detector failure.</p>	<p>Set up the AEM Monitor with the electrosurgical generator in the normal manner. Connect a return electrode to the Return Electrode receptacle of the Monitor, ensuring that the electrosurgical generator’s contact quality monitor is satisfied. Note: It may be necessary to add approximately 10 ohms of resistance between the dual pads of the return electrode to satisfy the ESU’s contact quality monitor. Connect a foot control instrument cord (with no instrument connected) to the Foot Control Instrument receptacle of the Monitor. Use a test lead with alligator clips to short together the two contacts of the exposed cord end. Insert an electrosurgical pencil electrode tip into the cord end until it makes contact with the active conductor. Connect one end of an additional test lead with alligator clips to one of the contacts of the cord end, leaving the other end free. Verify that the following occurs: all AEM Monitor fault indicators are extinguished; the Monitor Foot Control Instrument indicator illuminates green; the electrosurgical generator, with the contact quality monitoring system enabled, is in the normal operating state. Set the electrosurgical generator to 20 Watts in the standard coagulation mode. (For the ConMed 5000, set the power to 35 Watts in the standard coagulation mode.) Activate the coag output and carefully move the free alligator clip toward the pencil electrode tip until an arc is seen. If the AEM Monitor fails to light the text “Replace Instrument &amp; Cord,” return the AEM monitor for service.</p>

## Troubleshooting – End Point Monitor (Bipolar)

Situation	Possible Cause	Recommended Action
The Power On Self Test function (POST) did not take place when power was turned ON. <b>All</b> indicators are not on, and no beeps are heard.	Disconnected power cord, faulty wall receptacle, or faulty power cord.	Remove the power cord retainer bracket and check the power cord connections (monitor and wall receptacle). Connect the power cord to a functional wall receptacle. If necessary replace the power cord. Re-install the power cord retainer bracket.
	Fuse drawer is open or fuses are blown.	Turn off the AEM Monitor and unplug the unit from the wall receptacle. Open the fuse drawer. Check the fuses and replace, if necessary, with approved fuses. Reinstall the fuse drawer.
	Malfunctioning power entry module or connections.	Inspect the pins of the power entry module. If faulty, contact Encision Service Center.  If the above steps have failed, return the AEM Monitor for service.
No surgical effect	Faulty cord or instrument	Replace the cord and instrument.
No audible indication (no clicking), correct illumination on <b>Bipolar Current</b> indicator (bar graph).	The volume is muted.	Use the Volume Control buttons to increase the volume level. Ensure no objects are obstructing the speaker holes located on the bottom of the monitor. If the problem persists, return the AEM Monitor for service.
<b>Bipolar Current</b> indicator (bar graph) not illuminated on the AEM Monitor.		Return the AEM Monitor for service.
End Point Monitor Remote Display does not illuminate when plugged into the AEM Monitor and <b>Bipolar Current</b> indicator on front panel works properly.		Connect a different End Point Monitor Remote Display to the AEM Monitor.  If the problem persists, return both the AEM Monitor and original End Point Monitor Remote Display for service.

This page intentionally left blank.

# 5

## Principles of Operation

The AEM Monitor is divided into two separate functional parts: the AEM Monitor portion and the End Point Monitor portion.

### Theory of Operation – AEM Monitoring System (Monopolar)

The AEM Monitoring System enhances safety by detecting insulation breakdowns and blocking stray currents that may not be detected by the surgeon during electrosurgical procedures. Indicators identify “Set up” and “Operative” alarms so that the proper corrective action can be taken.

During minimally invasive procedures, monopolar electrosurgery has safety and performance issues that differ from those of open procedures.

The safety of the patient depends, in part, on the quality of electrical insulation on the extended electrodes, and the amount of current which is conducted through the insulation due to capacitance. These potential electrical problems are compounded by the fact that only a small portion of the total length of the insulation may be viewed by the surgical team.

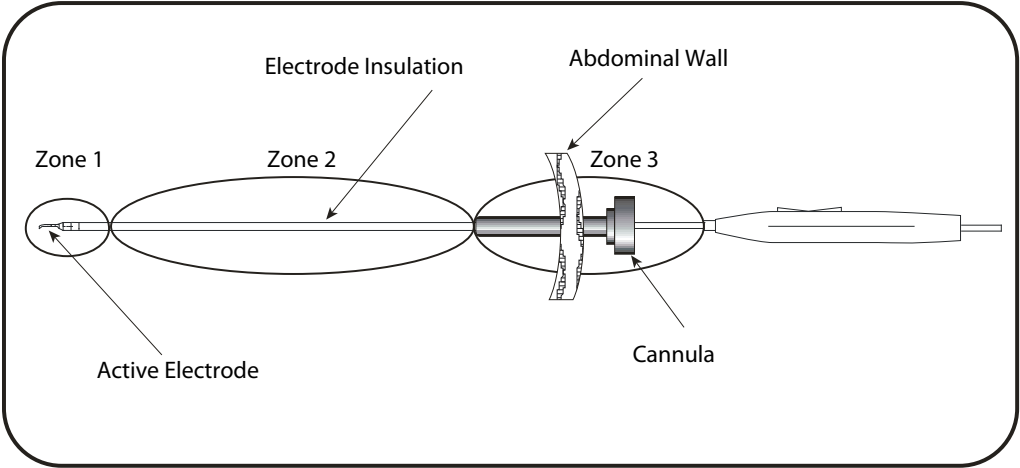

Zones 2 & 3 are likely out of the surgeon’s field of view.

Electrosurgical equipment produces high voltage radio-frequency energy. These high voltages require insulation on the electrodes to eliminate the flow of current except at the tip. Normal wear and tear of the instruments may degrade the insulation, and such defects may be outside of the normal field of view. Consequently, a failure capable of causing harm may go unnoticed.

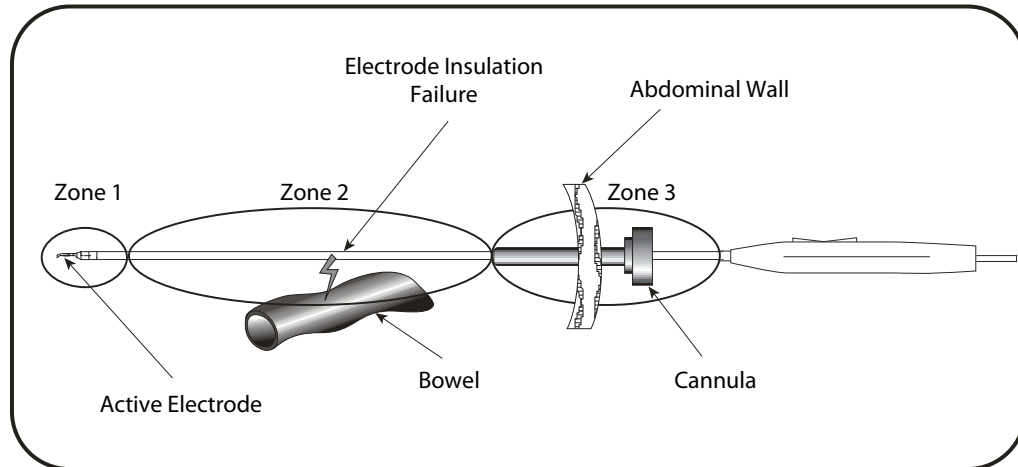

Capacitively coupled currents also have the potential for causing burns. The radio frequency energy used in electrosurgery will flow between closely spaced conductors even though there is no direct connection between them. The active electrode and a metallic cannula are closely spaced conductors, and they form a capacitor which can conduct radio frequency current. Testing has shown that 5% to 40% of the power indicated on the electrosurgical generator may be delivered from a metallic insulated trocar sheath to the patient's tissues. This amount of power is enough to cause a serious burn quickly.

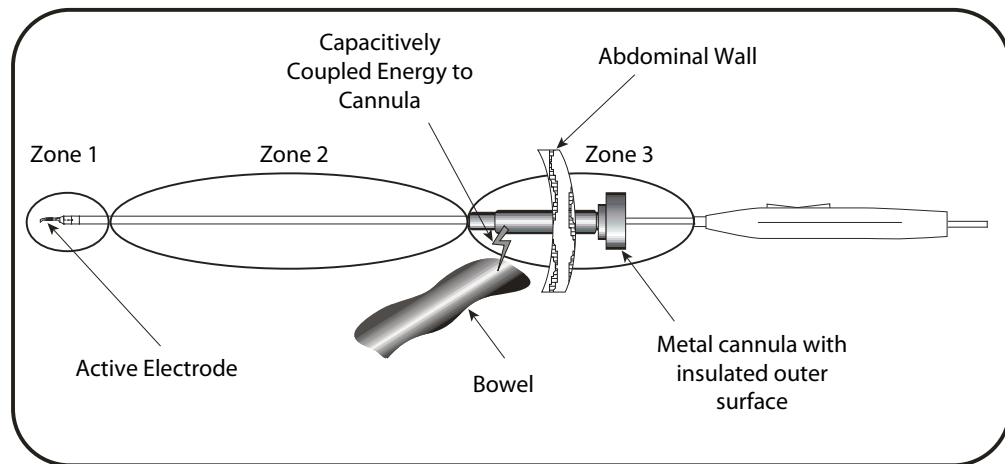

AEM instruments, in conjunction with an AEM Monitor properly connected to the electrosurgical generator (ESU), continuously monitor and dynamically manage "stray energy" (insulation failure and capacitive coupling) in zones 2 & 3.

**WARNING**

AEM shielding does not cover zone 1, which the surgeon should keep in view during instrument activation.

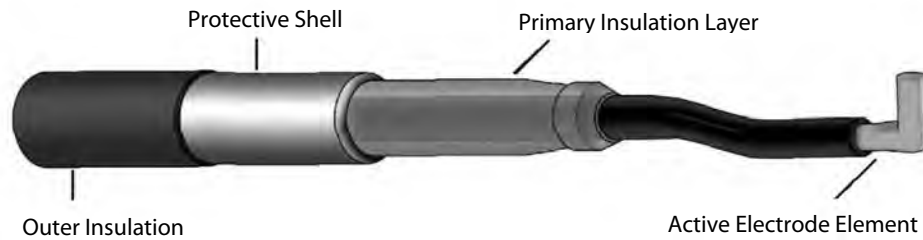

The AEM instruments incorporate a layered design. AEM instruments are shielded and monitored to prevent stray electrosurgical burns along the shaft of the instrument caused by insulation failure or capacitive coupling. The protective shield built into all AEM instruments provides a neutral return path for capacitively coupled energy and protection from insulation failure. The shield is continuously monitored during surgery which provides continuous assurance of the integrity of the instrument.

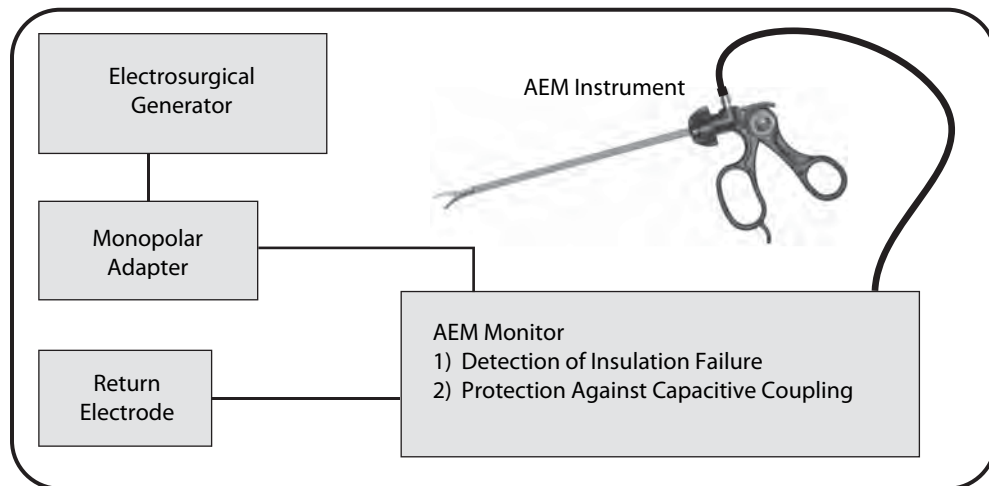

The AEM Monitor measures the currents flowing in the AEM integrated instruments, detects faults in the insulation, and monitors the connections of the shield and the return electrode. The Monopolar Adapter connects the AEM Monitor to an electrosurgical generator. AEM integrated instruments and the return electrode connect to the AEM Monitor. When an insulation fault or connection fault is detected, the AEM Monitor interrupts the circuit to the electrosurgical generator. In the event of a fault, an alarm sounds and a visual indicator illuminates.

#### NOTICE

The peak open circuit voltage produced by the electrosurgical generator may be slightly reduced when it is used with the AEM system. Normally the voltages produced under loaded conditions are not significantly altered.

## **Theory of Operation – End Point Monitoring System (Bipolar)**

The surgeon may use the End Point Monitor (a radio-frequency (RF) ammeter) to aid in determining the end point of bipolar electro-surgical desiccation.

Desiccation is a process whereby heat is dissipated in tissue, and the electrolytic fluid is driven away. As desiccation takes place the electrical impedance of the tissue and the flow of current changes. A bar graph displays the current in tenths of an ampere. As the current changes, the frequency of clicks changes.

Use the End Point Monitor in conjunction with visual, tactile, temporal, and aural information observed during surgery. The surgeon must use all the information presented and interpret it with reference to experience to determine that desiccation is satisfactorily completed. Thus, it is important not to draw conclusions about the completion of desiccation from the indications of the End Point Monitor alone.

# 6

## Surgical Use

### Before Surgery

For setup and system checks of the AEM Monitoring System, see Section 3 *System Setup*.

#### WARNING

Fire Hazard. Do not use extension cords.

Electric Shock Hazard. Connect the power cord to a properly grounded receptacle. Do not use power plug adapters.

Electric Shock Hazard. Do not attempt to connect or disconnect any cable during power activation.

Electric Shock Hazard. Do not connect wet accessories to the generator. Ensure that accessories and adapters are correctly connected and that no metal is exposed.

Do not use the AEM Monitor unless the system properly completes the automatic self-check. Otherwise, AEM functions may not be operative.

Good operating room practice suggests that connections of accessories to electrosurgical generators be made only while the generator is off or in standby mode.

Confirm proper power settings before proceeding with surgery. Use the lowest power setting possible for the minimum time necessary to achieve the desired surgical effect.

#### CAUTION

Connect the power cord to a wall outlet having the correct voltage. Otherwise product damage may result.

#### NOTICE

If you are familiar with the EM3 AEM Monitoring System, refer to the *Quick Setup Guide* for system connections and troubleshooting in the operating suite. The *Quick Setup Guide* can be stored in the Tray located at the front of the Monitor.



## Monopolar Surgery

Active electrode monitoring is intended to control stray monopolar energy caused by insulation failure and capacitive coupling on the shaft of the AEM instrument.

### **WARNING**

Only an AEM instrument provides active electrode monitoring. Other conductive objects at or near the surgical site are not protected. Do not touch those objects with the active instrument.

### **CAUTION**

The AEM system technology is designed to safely deliver electrosurgical energy and to prevent injury caused by insulation failure and capacitive coupling. The AEM Monitor is not intended to test for insulation damage on laparoscopic instruments. Do not attempt to use this system as an instrument inspection tool.

AEM Monitoring will not function without the use of a dual pad return electrode and an electrosurgical generator equipped with contact quality monitoring patient safety technology.

Read and review all instructions provided by the manufacturer of the dual pad return electrode you will be using.

Read and review all instructions provided by the manufacturer of the AEM accessories you will be using.

## Bipolar Surgery

End Point Monitoring of the bipolar instrument will assist the surgeon in confirming the end point of bipolar desiccation. This information is displayed on the left front panel of your AEM Monitor as an illuminated visual graph and a volume controlled audible indicator. If you are using the Encision End Point Monitor Remote Display (EMR), plug it into the receptacle found on the left rear panel of the AEM Monitor.

### WARNING

Electric Shock Hazard. Do not activate the generator bipolar output when the Bipolar Adapter is connected to the generator, but not connected to the AEM Monitor. Accessible pins of the adapter may lead to shock or burns to surgical personnel.

### CAUTION

The End Point Monitor activation clicks when an accessory is active. Do not turn the volume down below an audible level.

### NOTICE

If you are using the Encision End Point Monitor Remote Display (EMR), mount the display near the TV monitor or at another location in the view of the operating room staff.

## General Precautions

### Return Electrode

#### CAUTION

AEM Monitoring will not function without the use of a dual pad return electrode and an electrosurgical generator equipped with contact quality monitoring patient safety technology.

### Active Accessories

#### WARNING

These devices have been specifically designed for the use in electrosurgery. Do not use for other procedures.

Do not wrap accessory cords around metal objects. Wrapping cords around metal objects may induce currents that could lead to shocks, fires or injury.

The electrode tip may remain hot enough to cause burns after the electrosurgical current is deactivated.

When not in use, place accessories in a clean, dry, nonconductive and highly visible area not touching the patient. Inadvertent contact with the patient may result in burns.

Inadvertent activation or movement of the activated electrode tip outside the field of vision may result in injury to the patient. Use these instruments only under conditions that assure adequate visualization.

If electrodes are touching other instruments, do not activate them because unintended tissue damage may occur.

Contact of the active electrode with any metal (such as hemostats and clamps) will greatly increase current flow and can result in unintended burn injury.

When using laparoscopic instrumentation with metal cannulas, the potential exists for abdominal wall burns to occur in the event of direct electrode tip contact to the cannula.

Refer to the cannula manufacturer's instructions before inserting the electrode into the cannula. To avoid damaging the electrode or injuring the patient, insert and withdraw them carefully.

Inspect cords for breaks, cracks, nicks or other damage before every use. Verify that end of life indicators are not present. If any of these are present, do not use. Failure to observe this precaution may result in injury or electrical shock to the patient or operating personnel.

Damaged external insulation on instruments AND incorrect setup of the AEM Monitor may result in a risk of unintended patient burn. Do not use product having damaged insulation.

A single AEM instrument must be the sole conductor of energy to tissue. Do not conduct energy by touching an AEM instrument to a second instrument contacting tissue. The second device will not be protected from capacitive coupling and insulation failure.

**CAUTION**

Read the instructions, warnings, and cautions provided with the AEM Monitoring System accessories before using. Their specific instructions are not included in this manual.

Limit power setting to 80 watts or lower as specified in the power settings tables (see Section 3). Higher settings may result in spurious insulation failure alarms and/or insulation breakdown. Refer to instrument instructions for use for other limits.

Damaged internal insulation of the instrument, or loss of shield continuity, may cause interruption of energy delivery from the ESU. For maximum patient safety, discontinue use of the instrument if this occurs.

## Operating Room Troubleshooting

When using AEM Monitoring, successful electrosurgery depends on an absence of critical fault conditions. Should one occur, the AEM Monitoring System interrupts the power delivery from the electrosurgical generator (ESU) to the AEM instrument until the fault condition is corrected.

If for any reason a fault condition persists from the AEM Monitor after following the steps described below, use a backup AEM Monitor to complete the surgical procedure.

### Correcting Setup Faults

#### No Indicators Illuminate on the AEM Monitor

- Verify that the AEM Monitor power cord is plugged into an energized wall socket.
- Press the Reset Button.
- Turn the power switch off and wait 30 seconds before turning it back on.

#### No Power to Instrument

- Ensure that the Foot or Hand Control Instrument Indicator illuminates green.
- Ensure that the power settings on the electrosurgical generator are sufficient.
- If a foot control instrument is being used, ensure that the foot pedal is properly connected to the ESU.
- Reset the ESU's pad monitoring system (applies to some ESU models).
- Ensure that the ESU is functioning properly (refer to manufacturer's instructions).
- Verify that the Monopolar Adapter is properly and securely connected to the AEM Monitor and the ESU.
- Verify that the instrument in use is properly connected to the AEM Monitor.
- If the fault persists after performing all the previous steps, replace the instrument.
- If the fault continues to persist, use a backup AEM Monitor to complete the surgical procedure.

### Responding to Monitor Alarms

#### Return Electrode indicator illuminates amber (Setup Fault)

- Ensure that a dual pad return electrode (with a center pin at the plug) is connected to the AEM Monitor.
- Check that the return electrode connector is securely connected into the AEM Monitor Return Electrode receptacle.
- If using the Universal Monopolar Adapter, ensure that the return electrode lead of the adapter is plugged into the electrosurgical generator and not to the monitor.

- If both connections have been made and the amber indicator continues to illuminate, replace the return electrode.

**Instrument Cord Connection Fault (foot control) indicator blinks amber**  
(Setup Fault)

During this alarm condition, the Foot Control Instrument indicator also illuminates amber.

- Check the AEM Cord to ensure that it is securely connected to the Foot Control Instrument receptacle on the AEM Monitor and an AEM foot control instrument.
- If all connections are secure and the indicators continue to illuminate amber, replace the AEM Cord and the instrument one at a time to determine if one is defective. Replace the defective cord or instrument.

**Instrument Cord Connection Fault (hand control) indicator blinks amber**  
(Setup Fault)

During this alarm condition, the Hand Control Instrument indicator also illuminates amber.

- Check the AEM instrument cord to ensure that it is securely connected to the Hand Control Instrument receptacle on the AEM Monitor.
- If the connection is secure and the indicators continue to illuminate amber, replace the AEM instrument.

**The text “Replace Instrument & Cord” illuminates amber**  
(Operative Fault)

**WARNING**

An instrument insulation alarm indicates an unsafe active accessory.

At the onset of this alarm condition, the AEM Monitor interrupts the circuit to the electrosurgical generator for 10 seconds, the text “Replace Instrument & Cord” illuminates amber for 30 seconds, and the AEM Monitor generates an audio alert of 3 bursts of 3 beeps each. During this alarm condition, the instrument indicator for the active instrument also illuminates amber.

For a foot control instrument:

- Disconnect the AEM Cord from the AEM Monitor.
- Reconnect the AEM Cord (with an attached instrument) to the Foot Control Instrument receptacle on the AEM Monitor.
- Activate the instrument.
- If the indicators continue to illuminate amber, replace the instrument.
- If the indicators continue to illuminate amber after replacing the instrument, replace the AEM Cord.
- If the indicators continue to illuminate amber after replacing both the instrument and the AEM Cord, use a backup AEM Monitor to complete the surgical procedure.

For a hand control instrument:

- Disconnect the instrument cord from the AEM Monitor.
- Reconnect the instrument cord to the Hand Control Instrument receptacle on the AEM Monitor.
- Activate the instrument.
- If the indicators continue to illuminate amber, replace the instrument.
- If the indicators continue to illuminate amber after replacing the instrument, use a backup AEM Monitor to complete the surgical procedure.

## **Preparing the AEM Monitor for Reuse**

1. Turn off the AEM Monitor.
2. Disconnect all accessories.
3. Follow the cleaning procedure in Section 4.

**WARNING**

Electric Shock Hazard. Always unplug the AEM Monitor before cleaning.

# 7

## Technical Specifications

All specifications are subject to change without notice.

### Operating Modes - AEM Monitoring

#### **POST Mode**

The Power On Self Test function (POST) activates each time you turn on the AEM Monitor or when the Reset button is pressed. During POST, each LED indicator illuminates and two beeps sound.

#### **Monopolar Operating Mode**

The AEM Monitor detects improper setup conditions and detects operative faults by providing a monitored pathway for the current which is flowing from the shield to the patented return electrode. Fault conditions are indicated on the front panel and the Monitor interrupts the flow of energy from the electro-surgical generator (ESU) to the AEM instrument. Operative faults also generate an audible alarm.

#### **Bipolar Operating Mode**

The AEM Monitor measures the RF current flowing between the tines of a bipolar accessory. A number of segments on the display illuminate corresponding to the magnitude of current flowing between the tines of the accessory. The indicated current range is 0.1 A to 1.1 A. The AEM Monitor clicks at a rate proportional to the indicated current. The click volume is adjustable and can be muted if desired. A remote visual display may be plugged into the monitor and placed in a convenient viewing position.



## Functional Characteristics

### Monopolar Setup Fault Detection

If the return electrode is disconnected or the wrong type of return electrode is connected, an amber indicator illuminates to identify the deficiency.

If an AEM cord or AEM handpiece is connected to the monitor but the instrument is not connected or not connected properly, an amber indicator illuminates to identify the setup fault.

### Shield Cable and Return Electrode Switch Threshold

50 ohms  $\pm$  40%

### Monopolar Operative Fault Detection

If there is excessive shield current or arcing between the shield and the active electrode causing an operative fault, the amber instrument insulation failure indicator illuminates to identify an insulation fault, an audible alarm is generated, and the AEM Monitor interrupts the flow of energy from the electrosurgical generator to the AEM instrument.

### Radio Frequency Current Sensing

Current-sensing and spark detection are provided. Minimum electrosurgical generator output for reliable insulation fault detection: 20 Watts.

### Bipolar Current Measurement

The number of segments illuminated in the bar-graph display corresponds to the magnitude of the bipolar current. In addition to the visual display, the AEM Monitor generates clicks at a rate proportional to the measured current and the click volume is adjustable.

Accuracy: 20% of full scale

Range: 0.1 to 1.1 Amperes

Maximum current without damage: 3.0 Amperes

Click Rate: 2 Hz @ 0.1 Ampere, 40 Hz @ 1.1 Ampere

### Remote Bipolar Current Indication

An End Point Monitor Remote Display (EMR) is available which can be placed in a convenient viewing position. The EMR indicates the same information as the front panel display.

Cord Length: 15' (4.6 meters)

Duty Cycle: Continuous

## Indicators and Alert Functions

### Setup Fault Indicators

**Instrument Cord Connection Fault**, amber LEDs

Indicates that an AEM cord, instrument, or both are not properly connected to the AEM Monitor.

**Return Electrode Fault**, amber LED

Indicates that the return electrode is not properly connected, or that a dual pad electrode is not being used.

### Operative Fault Indicators

**Instrument Insulation Fault**, amber text “Replace Instrument & Cord”

Indicates that the instrument in use has an unsafe operating condition. Indicates that there is excessive current or arcing between the active electrode and the shield. Once triggered, the text illuminates for 30 seconds and there are 3 bursts of 3 beeps. The audio volume is fixed and cannot be adjusted or turned off.

### Status Indicators

**POST Reset Indicator**, green LED

Indicates that the AEM monitor has successfully completed the POST function.

**Instrument Indicators**, bi-color (green/amber) LEDs

If illuminated green, indicates that there are no faults and that the electrosurgical generator can be activated. If illuminated amber, indicates there is a fault condition with the corresponding instrument.

### Bipolar Current Indicator

**RF AMPERES**, 8 segment bar-graph display

The number of segments illuminated in the bar-graph display is proportional to the amount of bipolar current being delivered.

**Audible Indication**, adjustable volume clicks.

The clicks are delivered at a rate proportional to indicated current.

## Connectors and Cables

### **AEM Cord**

Connects the AEM Instrument active conductor to the electrosurgical generator and shield conductors to the AEM Monitor, both via the Monopolar Adapter.

Length: 10.5' (3.2 m) standard reusable cord  
9.5' (2.9 m) standard disposable cord  
12' (3.7 m) extended disposable cord (limited distribution)

### **Foot Control Instrument Receptacle**

A single active pin receptacle on the AEM Monitor front panel. Connects an AEM Cord to the AEM Monitor. There is no preferred polarity.

### **Hand Control Instrument Receptacle**

A receptacle on the AEM Monitor front panel. Connects an AEM Handpiece to the AEM Monitor. The design of the receptacle ensures that the AEM Handpiece is connected in the proper orientation.

### **Return Electrode Receptacle**

A vertically oriented dual pin receptacle on the AEM Monitor front panel. Connects a dual pad return electrode to the AEM Monitor.

### **Monopolar Adapter Receptacle**

A six pin receptacle on the top cover of the AEM monitor. Connects the Monopolar Adapter to the AEM Monitor. The design of the receptacle ensures the adapter is attached properly.

### **Bipolar Adapter**

Dual banana plugs on one end of a cord for making connection to the electrosurgical generator. A small shrouded plug with snap retention feature on the other end of the cord connects to the AEM Monitor. Connects the AEM Monitor to the electrosurgical generator for bipolar operation.

### **Bipolar Instrument Receptacle**

Two sockets arranged horizontally on the front panel provided for connecting to the bipolar instrument. There is no preferred polarity.

### **End Point Monitor Remote Display Receptacle**, rear panel

Four pin, male, XLR series, panel receptacle. Connects the remote display to the AEM Monitor. Attaching the cable activates the remote display.

### **Power Entry Module**, rear panel

UL/IEC type receptacle containing two, 0.5 A, 250V, slow blow, 5 × 20 mm fuses (one for each side of the line).

### **Power Cords**, attached to power entry module

A 15 ft (4.6 m) long, UL and CSA approved 120 V power cord or a 10' (3 m) long, VDE approved power cord (220-240V AC).

## Maximum Generator Voltage

4.5 KV<sub>peak</sub>

## Electrical Characteristics

### Input Power Requirements

100 - 240 V~ nominal rated voltage

50 / 60 Hz

Nominal current 0.2 A

Maximum current 0.5 A

### Chassis Source Leakage Current

200  $\mu$ A maximum

### Patient Leakage Current

Source or sink leakage current is 10  $\mu$ A maximum

## Dimensions and Weight

### External Dimensions

13.1" (33.3 cm) wide x 19.3" (49.0 cm) long x 2.5" (6.4 cm) high (does not include feet). Feet raise chassis 0.5" (1.3 cm).

### Weight

8 lbs (3.6 kg)

## Environmental Characteristics

### Operating Temperature

59 to 104° F (15 to 40° C)

### Storage and Transport Temperature

-13 to 158° F (-25 to 70° C)

### Operating, Storage and Transport Humidity

5% to 95% relative, non-condensing

### Atmospheric Pressure (Operating)

70 - 110 kPa

## Standards and IEC Classifications

### Class I Equipment per IEC 60601-1/EN 60601-1

Protection against electrical shock is provided by connection of accessible conductive parts to the protective ground conductor in such a way that they cannot become live in the event of a failure of basic insulation.

### Type CF Equipment per IEC 60601-1/EN 60601-1

The AEM Monitor provides a high degree of protection against electrical shock, particularly regarding allowable leakage currents, and has a CF type isolated (floating) applied part.



Type CF equipment with defibrillator protection



Equipotential Ground

#### CAUTION

Ordinary equipment is not protected against the ingress of water.

Medical Electrical Equipment needs special precautions regarding electromagnetic compatibility (EMC) and needs to be installed and put into service according to the EMC information provided herein.

Portable and mobile RF communications equipment can affect Medical Electrical Equipment.

### Electromagnetic emissions and immunity per IEC 60601-1-2/EN 60601-1-2

Manufacturer's declaration – electromagnetic emissions (EN 60601-1-2:2007)		
The Encision Model EM3 series AEM Monitor and accessories are intended for use in the electromagnetic environment specified below. The customer or user of the equipment should assure that it is used in such an environment.		
Emissions test	Compliance	Electromagnetic environment - guidance
RF emissions CISPR 11 / EN 55011	Group 1	The Model EM3 series AEM Monitor and accessories use RF energy only for its internal function. Therefore, its RF emissions are very low and not likely to cause any interference with nearby electronic equipment.
RF emissions CISPR 11 / EN 55011	Class A	The Model EM3 series AEM Monitor and accessories are suitable for use in all establishments other than domestic and those directly connected to the public low-voltage power supply network that supplies buildings used for domestic purposes.
Harmonic emissions IEC 61000-3-2	Class A	
Voltage fluctuations/ flicker emissions IEC 61000-3-3	Complies	

<b>Manufacturer's declaration – electromagnetic immunity (EN 60601-1-2:2007)</b>			
The Encision Model EM3 series AEM Monitor and accessories are intended for use in the electromagnetic environment specified below. The customer or user of the equipment should assure that it is used in such an environment.			
<b>Immunity test</b>	<b>IEC 60601 test level</b>	<b>Compliance level</b>	<b>Electromagnetic environment - guidance</b>
Electrostatic discharge (ESD)  IEC 61000-4-2	±6kV contact ±8 kV air	±6 kV contact ±8 kV air	Floors should be wood, concrete or ceramic tile. If floors are covered with synthetic material, the relative humidity should be at least 30%.
Electrical fast transient/burst  IEC 61000-4-4	±2kV for power supply lines ±1kV for input/output lines	±2kV for power supply lines ±1kV for input/output lines	Mains power quality should be that of a typical commercial or hospital environment.
Surge  IEC 61000-4-5	±1kV line(s) to line(s) ±2kV line(s) to earth	±1kV line(s) to line(s) ±2kV line(s) to earth	Mains power quality should be that of a typical commercial or hospital environment.
Voltage dips. Short Interruptions and voltage variations on power supply input lines  IEC 61000-4-11	<5%U <sub>T</sub> (>95% dip in U <sub>T</sub> ) for 0.5 cycle 40% U <sub>T</sub> (60% dip in U <sub>T</sub> ) for 5 cycles 70% U <sub>T</sub> (30% dip in U <sub>T</sub> ) for 25 cycles <5% U <sub>T</sub> (>95% dip in U <sub>T</sub> ) for 5 s	<5%U <sub>T</sub> (>95% dip in U <sub>T</sub> ) for 0.5 cycle 40% U <sub>T</sub> (60% dip in U <sub>T</sub> ) for 5 cycles 70% U <sub>T</sub> (30% dip in U <sub>T</sub> ) for 25 cycles <5% U <sub>T</sub> (>95% dip in U <sub>T</sub> ) for 5 s  U <sub>T</sub> = 230VAC 50Hz and 110VAC 50Hz	Mains power quality should be that of a typical commercial or hospital environment. If the user of the Model EM3 series AEM Monitor and accessories requires continued operation during power mains interruption, it is recommended that the Model EM3 series AEM Monitor and accessories be powered from an uninterruptible power supply or a battery.
Power frequency (50/60Hz) magnetic field  IEC 61000-4-8	3 A/m	50 and 60Hz, 3 A/m	Power frequency magnetic fields should be at levels characteristic of a typical location in a typical commercial or hospital environment.

<b>Guidance and manufacturer's declaration – electromagnetic immunity (EN 60601-1-2:2007)</b>			
The Encision Model EM3 series AEM and accessories are intended for use in the electromagnetic environment specified below. The customer or user of the equipment should be sure that it is used in such an environment.			
<b>Immunity test</b>	<b>IEC 60601 test level</b>	<b>Compliance level</b>	<b>Electromagnetic environment – guidance</b>
Conducted RF IEC 61000-4-6  Radiated RF IEC 61000-4-3	3 Vrms 150kHz to 80 MHz  3 V/m 80 MHz to 2.5 GHz	3 Vrms 150kHz to 80 MHz  3 V/m 80 MHz to 2.5 GHz	Portable and mobile RF communications  Equipment should be used no closer to any part of the Model EM3 series AEM Monitor and accessories, including cables, than the recommended separation distance calculated from the equation applicable to the frequency of the transmitter.  Recommended separation distance  $d = 1.2 \sqrt{P}$ 80 MHz to 800 MHz  $d = 1.2 \sqrt{P}$ 80 MHz to 800 MHz  $d = 2.3 \sqrt{P}$ 800 MHz to 2.5 GHz  Where P is the maximum output power rating of the transmitter in watts (W) according to the transmitter manufacturer and d is the recommended separation distance in meters (m).  Field strengths from fixed RF transmitters, as determined by an electromagnetic site survey <sup>a</sup> , should be less than the compliance level in each frequency range. <sup>b</sup>  Interference may occur in the vicinity of equipment marked with the following symbol.  
Note 1: At 80 MHz and 800 MHz, the higher frequency range applies. Note 2: These guidelines may not apply in all situations. Electromagnetic propagation is affected by absorption and reflection from structures, objects and people.			
<sup>a</sup> Field strengths from fixed transmitters, such as base stations for radio (cellular/cordless) telephone and land mobile radios, amateur radio, AM and FM radio broadcast and TV broadcast cannot be predicted theoretically with accuracy. To assess the electromagnetic environment due to fixed RF transmitters, an electromagnetic site survey should be considered. If the measured field strength in the location in which the AEM Monitor and accessories is used exceeds the applicable RF compliance level above, the equipment should be observed to verify to normal operation. If abnormal performance is observed, additional measures may be necessary, such as reorienting or relocating the equipment. <sup>b</sup> Over the frequency range 150 kHz to 80 MHz, the field strengths should be less than 3 Vm.			

<b>Recommended separation distances between portable and mobile RF communications equipment and the Model EM3 series AEM Monitor and accessories (EN 60601-1-2:2007)</b>			
The Model EM3 series AEM Monitor and accessories are intended for use in an electromagnetic environment in which radiated RF disturbances are controlled. The user of the Model EM3 series AEM Monitor and accessories can help prevent electromagnetic interference by maintaining a minimum distance between portable and mobile RF communications equipment (transmitters) and the Model EM3 series AEM Monitor and accessories as recommended below, according to the maximum output power of the of the communications equipment.			
Rated maximum output power of transmitter  W	Separation distance according to frequency of transmitter m		
	150 kHz to 80 MHz  $D = 1.2 \sqrt{P}$	80 MHz to 800 MHz  $D = 1.2 \sqrt{P}$	800 MHz to 2.5 GHz  $D = 2.3 \sqrt{P}$
0.01	0.12	0.12	0.23
0.1	0.38	0.38	0.73
1	1.2	1.2	2.3
10	3.8	3.8	7.3
100	12	12	23
For transmitters rated at a maximum out put power not listed above, the recommended distance d in meters (m) can be estimated using the equation applicable to the frequency of the transmitter, where P is the maximum output power rating of the transmitter in watts (W) according to the transmitter manufacturer. Note 1: At 80 MHz and 800 MHz, the separation distance for the higher frequency range applies. Note 2: These guidelines may not apply in all situations. Electromagnetic propagation is affected by absorption and reflection from structures, objects and people.			

Performance confirmed by electromagnetic immunity testing:

- Shield function
- Detection of insulation breakdown if threshold is reached
- Proper setup sequence, including detection of dual-area return electrode
- The AEM Monitor provides visual and audible indication of bipolar current (not likely to be affected by the adapter)



## Compatible Products

For successful operation, the EM3 AEM Monitor must be used with a set of compatible products. This includes the following:

- Electrosurgical generator with contact quality monitor
- Return electrode with dual-area design
- Active electrode
- EM3 Monopolar ESU Adapter or Bipolar ESU Adapter
- Active cable
- Trocar cannula

## Electrosurgical Generators

Electrosurgical Generator (ESU)		Encision Monopolar Adapter		Encision Bipolar Adapter
Manufacturer	Model	ESU Specific	or Universal	
ConMed	System 5000	EM3-40	EM3-60 <sup>1</sup>	BP9004
	Excalibur	not available	EM3-60 <sup>1</sup>	BP9003
Covidien	Valleylab Force FX	EM3-20	EM3-60 <sup>1</sup>	BP9004
	Force Triad	EM3-70	EM3-60 <sup>1</sup>	BP9004

<sup>1</sup> The EM3-60 Universal Monopolar Adapter may be used with all electrosurgical generators tested for use with the EM3 AEM Monitor.

### WARNING

Electrosurgical generators included in the above list have been tested for use with the EM3 AEM Monitor. Use of an untested ESU may result in an inoperative active electrode monitoring system. Contact Encision Customer Service for more information.

### CAUTION

All electrosurgical generators must have a contact quality monitoring circuit for return electrodes.

A designated Monopolar Adapter must be used with the electrosurgical generator to successfully complete setup of the AEM Monitoring System.

## Return Electrodes

The AEM Monitoring System requires a dual-area return electrode.

## Active Electrodes

The AEM Monitor must be used with instruments with patented AEM technology:

- manufactured by or for Encision Inc., or
- licensed by Encision Inc.

# 8

## Replacement Parts and Service

This section includes information on replacement parts and procedures for the AEM Monitor and instructions for returning the monitor for service.

### CAUTION

Refer all servicing to qualified personnel.

At the end of the monitor's product life, dispose of per local regulations for electrical equipment.

### Replacement Parts and Procedures

There are only two customer replaceable parts in the AEM Monitoring System. These parts do not require removal of the monitor cover. All other service must be performed by the Encision Service Center.

### NOTICE

Removal of the monitor cover will void the AEM Monitor warranty.

Customer Replaceable Parts		Part Number
A.C. Power Cord	115V	00492-000
	220-240V	Contact Encision
Fuse	5 × 20 mm, 0.5 Amp (250V)	04169-000

### Replacing the Fuse

### WARNING

Electric Shock Hazard. Disconnect the power cord before replacing parts.

### NOTICE

Fuse replacement procedure is only for external fuses.

1. Release the fuse drawer by inserting a small flat-head screwdriver into the slot at the bottom of the fuse drawer and pulling gently on the drawer. Slide the drawer out.
2. Remove the blown fuse from the drawer.
3. Replace the blown fuse with one of the same type and rating.
4. Slide the fuse drawer into its slot until it snaps into place.

## Returning the AEM Monitor

Before returning the AEM Monitor to Encision, call the Encision Customer Service Center to obtain a Return Material Authorization number (RMA) or call your Encision Representative for assistance. If you are returning the monitor for service, clean the monitor, then ship it to the Encision Service Center.

## Obtaining a Return Material Authorization Number

Have the following information ready when you call:

- hospital / clinic name / customer number
- telephone number
- department / address, city, state, and zip code
- model number
- serial number
- description of the problem

## Cleaning the Monitor

1. Follow the procedures approved by your institution or use a validated infection control procedure.
2. Use a mild cleaning solution (100:1 water to mild detergent, by mass) or disinfectant and a damp cloth to thoroughly wipe all outside surfaces and the power cord.

### CAUTION

Do not allow fluids to enter the chassis.

Do not clean the AEM Monitor with abrasive cleaning or disinfectant compounds, solvents, or other materials that could scratch the panels or damage the unit.

Do not steam sterilize the AEM Monitor.

## Shipping the Monitor

The monitor should be completely dry before you pack it for shipment. Package the monitor in its original shipping container, if available. Ship the monitor prepaid to the Encision Service Center.

## Service Center

Encision Inc.  
6797 Winchester Circle  
Boulder, Colorado, 80301-3513 USA

(303) 444-2600

[www.encision.com](http://www.encision.com)

## Limited Warranty

**Express Warranty:** ENCISION hereby warrants to Buyer that products purchased hereunder shall be free from defects in material and workmanship under normal use and service, as specified in ENCISION's product manuals and Instructions for Use provided with such product, for the period of:

- AEM Monitors – one (1) year from date of shipment to Buyer, or ninety (90) days from the date of shipment to Buyer of any repair, reconditioning or replacement thereof.
- Instruments and Accessories – as stated in the applicable Instructions for Use. This warranty shall run in favor of Buyer only, and is not enforceable by any other person or entity.

**Disclaimer:** The express warranties set forth in this agreement are in lieu of, and buyer hereby expressly waives, all other guarantees and warranties of any kind, whether express, implied or statutory including, without limitation, merchantability, fitness for particular purpose, non-infringement or by sample, and all such other warranties are hereby disclaimed and excluded by ENCISION. The sole and exclusive remedy for breach of ENCISION's warranty of the products shall be as stated herein.

**Exclusions:** The express warranty set forth above specifically excludes and does not apply to defects (i) caused through no fault of ENCISION during shipment to or from Buyer, (ii) caused by modifications or alterations made to the products by Buyer or any third party (iii) caused by unauthorized repair or maintenance performed on the products by Buyer or any third party, (iv) caused by the failure of Buyer to comply with any of the return procedures specified below, or (v) damaged by excessive current, temperature, physical stress or other deviation from the applicable environmental specifications.

**Limitation of Remedies:** ENCISION's sole obligation and Buyer's exclusive remedy for any breach of warranty is limited to the repair or replacement, at Encision's option, of any warranted product that is returned to ENCISION in its standard shipping container or properly packed in accordance with ENCISION's packing procedures, freight prepaid, where ENCISION's examination shows the product to have failed under normal use. If ENCISION's examination discloses that the returned product is not defective within the terms of this warranty, Buyer shall be subject to a \$200.00 charge per individual product for testing expenses incurred by ENCISION and the product will be returned to Buyer, freight collect. Such repair or replacement and reshipment at ENCISION's expense will be Buyer's sole and exclusive remedy for such defect. ENCISION will pay shipping charges for the repaired or replaced from ENCISION's factory to Buyer's location. If, notwithstanding the foregoing, Buyer ships any product to ENCISION's factory freight collect, then ENCISION shall ship the repaired or replaced product freight collect.

**Warranty Procedures:** Buyer shall request authorization from ENCISION prior to the return of each defective product for repair or replacement by ENCISION. Upon such request, ENCISION shall provide the address of the facility to which such product must be returned, together with Return Material Authorization (RMA) tracer number. ENCISION may, at its sole option, employ new or used parts for products to make such repair or replacement.

**Stored Data:** ENCISION shall not be liable for any loss or damage to any data stored in any product, including, without limitation, any data loss or damage resulting from any malfunction or defect or any loss or damage resulting from any inspection, repair, refurbishment, reconditioning or testing of the product or incurred in connection with transportation of the product to ENCISION or ENCISION's authorized repair center.

**Technical Assistance:** ENCISION's warranty shall not be enlarged, and no obligation or liability shall arise out of ENCISION's rendering of technical advice or assistance in connection with the products sold hereunder.

**Limitation of Liability:** To the extent allowable by applicable law, in no event shall ENCISION be liable for any special, incidental or consequential damages in connection with or arising out of the sale, installation, use, operation, service or repair of any product, whether based on breach of warranty or contract, strict liability, negligence or otherwise, whether or not ENCISION shall have been advised as to the possibility or reason for any such potential loss or damage. Direct damages shall be strictly limited to the cost to Buyer of the products sold or provided to Buyer, notwithstanding any failure of essential purpose of any limited remedy.