

# ENCISION®

## ***AEM® Monitor***

### *Operator/Service Manual*



***with AEM® Technology***



***Operator/Service Manual***

---

***AEM<sup>®</sup> Monitor***

***EM2AB (115v)***

---

**Manufactured by:**

Encision Inc.  
6797 Winchester Circle  
Boulder, Colorado 80301-3513  
Ph: 303-444-2600 Fax: 303-444-2693

Made in USA

**US Patents # 5,312,401, #5,688,269. Other Patents Pending**

**International Patents:**

Japan Patent # 2,509,081  
Canada Patent # 2,112,817  
European Patent Convention # 0596909  
Australia Patent # 667322

**Trademark acknowledgments:**

Encision<sup>®</sup> is a registered trademark of Encision Inc.  
AEM<sup>®</sup> is a registered trademark of Encision Inc.  
REM<sup>™</sup> is a trademark of Covidien/Valleylab  
ARM<sup>™</sup> is a trademark of ConMed/Aspen Labs

Printed in USA

Part Number: 00377-004 2011/09  
© 2011 Encision Inc. All rights reserved.



ETL LISTED  
MEDICAL ELECTRICAL EQUIPMENT  
CONFORMS TO UL STD 60601-1

---

**Table of Contents**

	<b>Page</b>
<b>Foreword</b>	
Indications for Use .....	i
Conventions Used in This Manual .....	ii
Warnings and Cautions .....	iii
<b>A Accessories, Instructions for Use/Care .....</b>	<b>A - 1</b>
<b>1 Introduction</b>	
Unpacking your System .....	1 - 1
Active Electrode Monitoring .....	1 - 2
Monopolar Surgery .....	1 - 2
Bipolar Surgery .....	1 - 2
<b>2 Controls, Indicators, and Receptacles</b>	
Front Panel .....	2 - 1
Right Side Panel .....	2 - 3
Left Side Panel .....	2 - 3
<b>3 Setup and Tests</b>	
Setup of the AEM Monitoring System (Monopolar) .....	3 - 1
Checking the AEM Monitoring System (Monopolar) .....	3 - 4
Setup of the End Point Monitoring System (Bipolar) .....	3 - 7
Checking the End Point Monitoring System (Bipolar) .....	3 - 8
Mechanical Inspection .....	3 - 9
Electrical Inspection .....	3 - 9
Cleaning .....	3 - 10
Storing the AEM Monitor .....	3 - 10
<b>4 Troubleshooting .....</b>	
	<b>4 - 1</b>
<b>5 Principles of Operation</b>	
Theory of Operation – AEM (Monopolar) .....	5 - 1
Circuit Operation (Monopolar) .....	5 - 4
Theory of Operation - End Point Monitoring System .....	5 - 8
Circuit Operation (Bipolar) .....	5 - 8
<b>6 Surgical Use</b>	
Before Surgery .....	6 - 1
Monopolar Surgery .....	6 - 2
Checking the AEM Monitoring System .....	6 - 3
Bipolar Surgery .....	6 - 4
Checking the End Point Monitoring System .....	6 - 5
General Precautions .....	6 - 6
Responding to Monitor Alarms .....	6 - 7
Preparing the AEM Monitor for Reuse .....	6 - 8

	<b>Page</b>
<b>7 Technical Specifications</b>	
Operating Modes - AEM Monitoring .....	7 - 1
Functional Characteristics .....	7 - 2
Indicators and Alert Functions .....	7 - 3
Connectors and Cables .....	7 - 3
Electrical Characteristics .....	7 - 5
Dimensions and Weight .....	7 - 5
Environmental Characteristics .....	7 - 5
Standards and IEC Classifications .....	7 - 6
Compatible Products .....	7 - 10
<b>8 Replacement Procedures .....</b>	<b>8 - 1</b>
<b>9 Repair Policy And Procedures</b>	
Obtaining a Return Authorization Number .....	9 - 1
Returning the Monitor for Service .....	9 - 1
Cleaning .....	9 - 1
Shipping the Monitor .....	9 - 2
Service Center .....	9 - 2
Limited Warranty .....	9 - 3
<b>10 Service Parts .....</b>	<b>10 - 1</b>

## **Service Center**

---

Encision Inc.  
6797 Winchester Circle  
Boulder, Colorado 80301-3513 USA

(303) 444-2600

[www.encision.com](http://www.encision.com)

## Foreword

---

This manual and the equipment it describes are for use only by qualified medical professionals trained in the particular technique and surgical procedure to be performed. This manual is intended as a guide for servicing the AEM Monitor, including its setup and operation. It is not intended to be a general reference about the use of electrosurgery either in general application or in laparoscopic procedures.

### Indications for Use:

The Encision AEM Monitoring System is an accessory for use with electrosurgical generators and electrodes that is designed to safely deliver electrosurgical energy and to prevent injury caused by insulation failure and capacitive coupling.

The AEM Monitoring System consists of two distinct functions:

- Active electrode monitoring is intended to control stray monopolar energy caused by insulation failure and capacitive coupling in surgical instruments on the shaft of the instrument.
- End point monitoring is intended to aid the surgeon in determining the end point of bipolar electrosurgical desiccation.

### Contraindications:

There are no known contraindications for use of the AEM Monitor.

#### Caution

READ AND REVIEW ALL INSTRUCTIONS IN THIS MANUAL, AND IN INSTRUMENT AND ACCESSORIES INSTRUCTIONS FOR USE, PRIOR TO USING THE AEM SYSTEM.

#### Caution

FEDERAL (USA) LAW RESTRICTS THIS DEVICE TO SALE BY OR ON THE ORDER OF A PHYSICIAN.

#### Caution

THE AEM MONITOR IS DESIGNED TO SAFELY DELIVER ELECTROSURGICAL ENERGY AND TO PREVENT INJURY CAUSED BY INSULATION FAILURE AND CAPACITIVE COUPLING. THE ENCISION AEM MONITOR IS NOT INTENDED TO TEST FOR INSULATION DAMAGE ON LAPAROSCOPIC INSTRUMENTS. DO NOT ATTEMPT TO USE THIS SYSTEM AS AN INSTRUMENT INSPECTION TOOL.

## Conventions Used in this Manual

---

### Warning

INDICATES A POTENTIALLY HAZARDOUS SITUATION WHICH, IF NOT AVOIDED, COULD RESULT IN SERIOUS INJURY OR DEATH.

### Caution

INDICATES A HAZARDOUS SITUATION WHICH, IF NOT AVOIDED, MAY RESULT IN MINOR OR MODERATE INJURY.

---

### Notice

---

INDICATES A HAZARD WHICH MAY RESULT IN PRODUCT DAMAGE.

Controls, indicators, and receptacles on the unit appear in bold and/or italic capitals like this:

**RETURN ELECTRODE**, *RETURN ELECTRODE*, *Return Electrode*

---

## Warnings and Cautions

---

Please refer to the manual of your electrosurgical generator for applications information including warnings and precautions regarding its use before proceeding further.

### Explosion, Fire and Shock Hazards

---

#### Warning

**EXPLOSION HAZARD.** DO NOT USE ELECTROSURGERY IN THE PRESENCE OF FLAMMABLE ANESTHETICS.

**FIRE/EXPLOSION HAZARD.** THE FOLLOWING SUBSTANCES WILL CONTRIBUTE TO INCREASED FIRE AND EXPLOSION HAZARDS IN THE OPERATING ROOM:

- FLAMMABLE SUBSTANCES (SUCH AS ALCOHOL BASED SKIN PREPPING AGENTS AND TINCTURES).
- NATURALLY OCCURRING FLAMMABLE GASES WHICH MAY ACCUMULATE IN BODY CAVITIES SUCH AS THE BOWEL.
- OXYGEN AGENTS (SUCH AS NITROUS OXIDE [N<sub>2</sub>O] ATMOSPHERES).

THE SPARKING AND HEATING ASSOCIATED WITH ELECTROSURGERY CAN PROVIDE AN IGNITION SOURCE. OBSERVE FIRE PRECAUTIONS AT ALL TIMES. WHEN USING ELECTROSURGERY IN THE SAME ROOM WITH ANY OF THESE SUBSTANCES OR GASES, PREVENT THEIR ACCUMULATION OR POOLING UNDER SURGICAL DRAPES, OR WITHIN THE AREA WHERE ELECTROSURGERY IS PERFORMED.

**FIRE HAZARD.** DO NOT USE EXTENSION CORDS.

**FIRE HAZARD.** FOR CONTINUED PROTECTION AGAINST FIRE HAZARD REPLACE FUSES ONLY WITH THE SAME TYPE AND RATING.

**FIRE HAZARD.** ELECTROSURGICAL ACCESSORIES THAT ARE ACTIVATED OR HOT FROM USE CAN CAUSE A FIRE. DO NOT PLACE THEM NEAR OR TOUCHING FLAMMABLE MATERIALS (SUCH AS GAUZE OR SURGICAL DRAPES).

**ELECTRIC SHOCK HAZARD.** CONNECT THE GENERATOR POWER CORD TO A PROPERLY GROUNDED RECEPTACLE. DO NOT USE POWER STRIP PLUG ADAPTERS.

**ELECTRIC SHOCK HAZARD.** ENSURE THAT ALL ACCESSORIES, CORDS, AND ADAPTERS ARE CORRECTLY CONNECTED AND THAT NO METAL IS EXPOSED.

**ELECTRIC SHOCK HAZARD.** DO NOT CONNECT A WET POWER CORD TO THE AEM MONITOR OR TO THE WALL RECEPTACLE.

**ELECTRIC SHOCK HAZARD.** ALWAYS UNPLUG THE AEM MONITOR BEFORE CLEANING.



### General Electrosurgical Hazards

---

#### Warning

ANY ELECTROSURGICAL PROCEDURE IS SAFEST IF MODERATE CONTROL SETTINGS ARE USED ALONG WITH MINIMUM ACTIVATION TIMES. PROLONGED ACTIVATIONS WITHOUT THE ELECTRODE IN CONTACT WITH THE TISSUE SHOULD BE AVOIDED.

CONFIRM PROPER ELECTROSURGICAL POWER SETTING BEFORE PROCEEDING WITH SURGERY. USE THE LOWEST POWER SETTING THAT ACHIEVES THE DESIRED SURGICAL EFFECT.

IN ORDER TO LESSEN THE POSSIBILITY OF CREATING UNINTENDED BURNS, ACTIVATE THE ELECTROSURGICAL GENERATOR ONLY WHEN THE ACTIVE ELECTRODE IS NEAR OR TOUCHING THE TARGET TISSUE.

THE SAFE USE OF MONOPOLAR ELECTROSURGERY REQUIRES PROPER PLACEMENT OF THE PATIENT RETURN ELECTRODE. TO AVOID ELECTROSURGICAL BURNS BENEATH THE PATIENT RETURN ELECTRODE, FOLLOW ALL DIRECTIONS ON THE PRODUCT PACKAGE FOR PROPER RETURN ELECTRODE PLACEMENT AND USE.

IN SOME CIRCUMSTANCES, POTENTIAL EXISTS FOR ALTERNATE SITE BURNS AT POINTS OF SKIN CONTACT (E.G., BETWEEN THE ARM AND THE SIDE OF THE BODY). THIS OCCURS WHEN ELECTROSURGICAL CURRENT SEEKS A PATH TO THE PATIENT RETURN ELECTRODE THAT INCLUDES THE SKIN TO SKIN CONTACT POINT. CURRENT PASSING THROUGH SMALL SKIN TO SKIN CONTACT POINTS IS CONCENTRATED AND MAY CAUSE A BURN. THIS IS TRUE FOR EARTH REFERENCED AND ISOLATED OUTPUT GENERATORS.

TO REDUCE THE POTENTIAL FOR ALTERNATE SITE SKIN BURNS, DO ONE OR MORE OF THE FOLLOWING:

- AVOID SKIN TO SKIN CONTACT POINTS, SUCH AS FINGERS TOUCHING LEG, WHEN POSITIONING THE PATIENT.
- PLACE TWO TO THREE INCHES OF DRY GAUZE BETWEEN CONTACT POINTS TO ENSURE THAT CONTACT DOES NOT OCCUR.
- POSITION THE PATIENT RETURN ELECTRODE TO PROVIDE A DIRECT CURRENT ROUTE BETWEEN THE SURGICAL SITE AND THE RETURN ELECTRODE WHICH AVOIDS SKIN-TO-SKIN CONTACT.
- IN ADDITION, PLACE PATIENT RETURN ELECTRODES ACCORDING TO THE MANUFACTURER'S INSTRUCTIONS.

KEEP ELECTRICAL CONNECTIONS DRY WHILE IN USE TO PREVENT POTENTIAL CONDUCTION OF HF CURRENT TO THE USER.

POTENTIALLY HAZARDOUS CONDITIONS MAY EXIST WHEN ACCESSORIES OF SIMILAR CONNECTOR TYPES ARE INTERMIXED. BE CERTAIN THAT ACCESSORIES ARE APPROPRIATE FOR THE TYPE OF ELECTROSURGICAL GENERATOR OUTPUT USED AND THE INTENDED APPLICATION.

LAPAROSCOPIC SURGERY MAY RESULT IN GAS EMBOLISM DUE TO INSUFFLATION OF GAS INTO THE ABDOMEN.

---

**General Electrosurgical Hazards, continued.**

---

**Warning**

WHILE USING ELECTROSURGERY, THE PATIENT SHOULD NOT BE ALLOWED TO COME INTO DIRECT CONTACT WITH GROUNDED METAL OBJECTS (E.G., SURGICAL TABLE FRAME, INSTRUMENT TABLE, ETC.). IF THIS IS NOT POSSIBLE DURING CERTAIN PROCEDURES (E.G., THOSE IN WHICH NONINSULATED HEAD FRAMES ARE USED), USE EXTREME CAUTION TO MAXIMIZE PATIENT SAFETY:

- USE THE LOWEST POWER SETTING THAT ACHIEVES THE DESIRED EFFECT.
- PLACE THE PATIENT RETURN ELECTRODE AS CLOSE TO THE SURGICAL SITE AS POSSIBLE.
- PLACE DRY GAUZE BETWEEN THE PATIENT AND THE GROUNDED OBJECT IF POSSIBLE.
- CONTINUALLY MONITOR THE CONTACT POINT(S).

**Active Accessories and AEM Monitor**

---

**Warning**

THESE DEVICES HAVE BEEN SPECIFICALLY DESIGNED FOR USE IN ELECTROSURGERY. DO NOT USE FOR OTHER PROCEDURES.

DO NOT WRAP ACCESSORY CORDS AROUND METAL OBJECTS. WRAPPING CORDS AROUND METAL OBJECTS MAY INDUCE CURRENTS THAT COULD LEAD TO SHOCKS, FIRES OR INJURY.

THE ELECTRODE TIP MAY REMAIN HOT ENOUGH TO CAUSE BURNS AFTER THE ELECTROSURGICAL CURRENT IS DEACTIVATED.

WHEN NOT IN USE, PLACE ACCESSORIES IN A CLEAN, DRY, NONCONDUCTIVE AND HIGHLY VISIBLE AREA NOT TOUCHING THE PATIENT. INADVERTENT CONTACT WITH THE PATIENT MAY RESULT IN BURNS.

INADVERTENT ACTIVATION OR MOVEMENT OF THE ACTIVATED ELECTRODE TIP OUTSIDE THE FIELD OF VISION MAY RESULT IN INJURY TO THE PATIENT. USE THESE INSTRUMENTS ONLY UNDER CONDITIONS THAT ASSURE ADEQUATE VISUALIZATION.

LOCALIZED BURNS TO THE PATIENT OR PHYSICIAN MAY COME FROM ELECTRICAL CURRENTS CARRIED THROUGH CONDUCTIVE OBJECTS (SUCH AS CANNULAS OR SCOPES). ELECTRICAL CURRENT MAY BE GENERATED IN CONDUCTIVE OBJECTS BY DIRECT CONTACT WITH THE ACTIVE ACCESSORY CABLE BEING IN CLOSE PROXIMITY TO THE CONDUCTIVE OBJECT.

ENSURE THAT THE INSULATION OF CONVENTIONAL, NONSHIELDED DISPOSABLE AND REUSABLE LAPAROSCOPIC INSTRUMENTATION IS INTACT. COMPROMISED INSULATION OF NONSHIELDED INSTRUMENTS MAY LEAD TO SHOCKS OR BURNS TO THE PATIENT OR SURGICAL PERSONNEL.

WHEN USING LAPAROSCOPIC INSTRUMENTATION WITH METAL CANNULAS, THE POTENTIAL EXISTS FOR ABDOMINAL WALL BURNS TO OCCUR IN THE EVENT OF DIRECT ELECTRODE TIP CONTACT TO THE CANNULA.

**Active Accessories and AEM Monitor, continued.**

---

**Warning**

REFER TO THE CANNULA MANUFACTURER'S INSTRUCTIONS BEFORE INSERTING THE ELECTRODE INTO THE CANNULA. TO AVOID DAMAGING THE ELECTRODE OR INJURING THE PATIENT, INSERT AND WITHDRAW THEM CAREFULLY.

INSPECT CORDS FOR BREAKS, CRACKS, NICKS OR OTHER DAMAGE BEFORE EVERY USE. ENSURE THAT END OF LIFE INDICATORS ARE NOT PRESENT. IF ANY OF THESE ARE PRESENT, DO NOT USE. FAILURE TO OBSERVE THIS PRECAUTION MAY RESULT IN INJURY OR ELECTRICAL SHOCK TO THE PATIENT OR OPERATING PERSONNEL.

DAMAGED EXTERNAL INSULATION ON INSTRUMENTS AND INCORRECT SETUP OF THE AEM MONITOR MAY RESULT IN A RISK OF UNINTENDED PATIENT BURN. DO NOT USE PRODUCT HAVING DAMAGED INSULATION.

**Caution**

READ THE INSTRUCTIONS, WARNINGS, AND CAUTIONS PROVIDED WITH THE AEM MONITORING SYSTEM ACCESSORIES BEFORE USING. THEIR SPECIFIC INSTRUCTIONS ARE NOT INCLUDED IN THIS MANUAL.

WHEN AN ALERT IS PRESENTED BY THE AEM MONITOR, DISCONTINUE USE OF THE ELECTROSURGICAL CURRENT IMMEDIATELY. FIND THE CAUSE OF THE ALERT AND CORRECT IT BEFORE CONTINUING USE.

AEM MONITORING WILL NOT FUNCTION WITHOUT THE USE OF DUAL PAD PATIENT RETURN ELECTRODES AND AN ELECTROSURGICAL UNIT EQUIPPED WITH CONTACT QUALITY MONITORING PATIENT SAFETY TECHNOLOGY.

DAMAGED INTERNAL INSULATION OF THE INSTRUMENT, OR LOSS OF SHIELD CONTINUITY, MAY CAUSE ESU RETURN PAD ALARMS TRIGGERED BY THE AEM MONITOR'S FAULT INDICATORS. FOR MAXIMUM PATIENT SAFETY, DISCONTINUE USE OF THE INSTRUMENT IF THIS OCCURS.

A SINGULAR AEM INSTRUMENT MUST BE THE SOLE CONDUCTOR OF ENERGY TO TISSUE. DO NOT CONDUCT ENERGY BY TOUCHING AN AEM INSTRUMENT TO A SECOND INSTRUMENT CONTACTING TISSUE. THE SECOND DEVICE WILL NOT BE PROTECTED FROM CAPACITIVE COUPLING AND INSULATION FAILURE.

LIMIT POWER SETTING TO 80 WATTS OR LOWER, UNLESS FURTHER LIMITED BY THE INSTRUMENT INSTRUCTIONS FOR USE. OTHERWISE, SPURIOUS INSULATION FAILURE ALARMS MAY OCCUR.

GOOD OPERATING ROOM PRACTICE SUGGESTS THAT CONNECTIONS OF ACCESSORIES TO ELECTROSURGICAL GENERATORS BE MADE ONLY WHILE THE GENERATOR IS *OFF* OR ON *STANDBY*.

DO NOT USE THE AEM MONITOR UNLESS THE SYSTEM PROPERLY COMPLETES THE AUTOMATIC SELF-CHECK. OTHERWISE, AEM FUNCTIONS MAY NOT BE OPERATIVE.

## Electromagnetic Compatibility Hazards

### Caution















USE OF ACCESSORIES, TRANSDUCERS AND CABLES OTHER THAN THOSE SPECIFIED, WITH THE EXCEPTION OF TRANSDUCERS AND CABLES SOLD BY THE MANUFACTURER OF THE EQUIPMENT OR SYSTEM AS REPLACEMENT PARTS FOR INTERNAL COMPONENTS, MAY RESULT IN INCREASED EMISSIONS OR DECREASED IMMUNITY OF THE EQUIPMENT OR SYSTEM.

AEM MONITOR SHOULD NOT BE USED ADJACENT TO OR STACKED WITH OTHER EQUIPMENT EXCEPT AS SPECIFIED HEREIN. IF ADJACENT OR STACKED USE IS NECESSARY, THE EQUIPMENT SHOULD BE OBSERVED TO VERIFY NORMAL OPERATION IN THE CONFIGURATION IN WHICH IT WILL BE USED.

FOLLOW THE ELECTROSURGERY UNIT MANUFACTURERS INSTRUCTIONS AS FAR AS LOCATING EQUIPMENT WITHIN THE OPERATING ROOM TO DIMINISH OR ELIMINATE RADIO FREQUENCY ELECTRICAL INTERFERENCE WITH OTHER ELECTRONIC EQUIPMENT.

MEDICAL ELECTRICAL EQUIPMENT NEEDS SPECIAL PRECAUTIONS REGARDING EMC AND NEEDS TO BE INSTALLED AND PUT INTO SERVICE ACCORDING TO THE EMC INFORMATION PROVIDED IN THE ACCOMPANYING DOCUMENTS. PORTABLE AND MOBILE RF COMMUNICATIONS EQUIPMENT CAN AFFECT MEDICAL ELECTRICAL EQUIPMENT.

## Symbol Definitions

	<b>Caution</b>		<b>Power</b>
	<b>Consult instructions for use</b>		<b>Ready</b>
	<b>Type CF equipment with defibrillator protection</b>		<b>Insulation operative fault</b>
<b>REF</b>	<b>Catalog Number</b>		<b>Return Electrode setup fault</b>
	<b>Serial Number</b>		<b>AEM Cord setup fault</b>
	<b>Manufacturing Date</b>		<b>Bipolar Accessory</b>
	<b>Manufacturer</b>		<b>Bipolar Jumper Cord</b>
	<b>Protective Earth (Ground)</b>		

This page intentionally left blank.

## A Accessories, Instructions for Use/Care

---

This section is intended to provide the user with an area to add the Instructions for Use/Care. These instructions are provided with the accessories, are for reference only, and are subject to change without notice.

THE AEM MONITOR IS TO BE USED WITH ENCISION ACCESSORIES, INCLUDING:

- END POINT MONITOR REMOTE DISPLAY
- AEM CORD
- AEM CORD ADAPTER
- UNIVERSAL ADAPTER
- BIPOLAR JUMPER CORD
- BIPOLAR INSTRUMENT CORDS
- AEM HANDLE ASSEMBLY
- REUSABLE AND DISPOSABLE INSERTS
- DISPOSABLE SHEATH
- FIXED TIP ELECTRODES
- SUCTION IRRIGATION ELECTRODES
- DISPOSABLE ELECTRODES AND HAND-CONTROL HANDPIECES
- AC INPUT CORD, HOSPITAL GRADE 120V, 15' (4.6 M)

OR ENCISION-APPROVED COMPATIBLE ACCESSORIES.

### Warning

USE OF OTHER ACCESSORIES OR CABLES MAY RESULT IN INCREASED EMC EMISSIONS OR DECREASED IMMUNITY.

CONTACT CUSTOMER SERVICE AT (303) 444-2600 FOR CURRENT CATALOG OR GO TO [WWW.ENCISION.COM](http://WWW.ENCISION.COM).

This page intentionally left blank.

---

# 1 Introduction

---

**Congratulations on your purchase of the AEM Monitor. This is state of the art technology that dynamically manages and monitors stray monopolar current.**

## Caution

THE AEM SYSTEM IS DESIGNED TO SAFELY DELIVER ELECTROSURGICAL ENERGY AND TO PREVENT INJURY CAUSED BY INSULATION FAILURE AND CAPACITIVE COUPLING. THE ENCISION AEM SYSTEM IS NOT INTENDED TO TEST FOR INSULATION DAMAGE ON LAPAROSCOPIC INSTRUMENTS. DO NOT ATTEMPT TO USE THIS SYSTEM AS AN INSTRUMENT INSPECTION TOOL.

**The AEM Monitor consists of two distinct functions:**

- **Active Electrode Monitoring** – Intended to control stray monopolar energy caused by insulation failure and capacitive coupling in surgical instruments on the shaft of the instrument.
- **End Point Monitoring** – Intended to aid the surgeon in determining the end point of bipolar electro-surgical desiccation.

## Unpacking your System

---

Your system is shipped in one carton. We suggest that you store this carton so that it will be available if the need for service arises.

Carefully unpack the carton. Check to ensure you received the following parts. (If any of these parts are missing, please contact our service center as soon as possible.)

- AEM Monitor
- Power Cord
- Bipolar Jumper Cord
- Setup Card
- Operator/Service Manual (CD version or hard copy)

Contact Customer Service at (303) 444-2600 to arrange for repair or replacement of any parts damaged from shipping.



### **Active Electrode Monitoring**

---

Active electrode monitoring technology can eliminate the risk of stray electrical energy caused by insulation failure and capacitive coupling and thus helps to prevent unintended internal burn injury to the patient. AEM instruments direct electrosurgical energy where the surgeon desires, while continuously monitoring the current flow to prevent stray electrosurgical energy from insulation failure or capacitive coupling.

AEM instruments have a patented, multi-layered design with a built-in shield, much like the third wire ground in standard electrical cords. The shield in these instruments is referenced back to a monitor at the electrosurgical generator. In the event of a harmful level of stray electrical energy, the monitor shuts down the power at the source, ensuring patient safety. The AEM system protects against capacitive coupling by providing a neutral return path for capacitively coupled electrical current. Capacitively coupled energy is continually drained away from the instrument and away from the patient through the protective shield built into all AEM instruments.

### **Monopolar Surgery**

---

In monopolar electrosurgery, the surgical instrument contains only the active electrode. A separate return electrode to the patient recovers the current that passes through the patient and returns it safely to the generator.

Monopolar electrosurgery is used for most surgical procedures that require sparking to tissue, such as those in which tissue must be cut or coagulated over wide areas.

### **Bipolar Surgery**

---

In bipolar electrosurgery, the surgical instrument includes both electrodes. A patient return electrode need not be used. Current flows between the two electrodes and through the tissue contacted by the instrument, heating that tissue.

In bipolar electrosurgery, control is needed to ensure the correct degree of heating.

## 2 Controls, Indicators, and Receptacles

The AEM Monitor front and side panel features are illustrated and described in this section.

### Front Panel

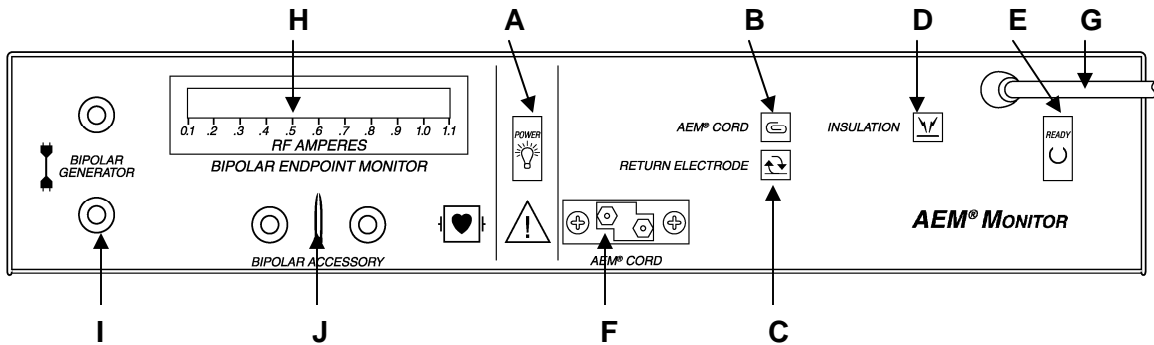

POWER



#### A POWER Green Indicator

Illuminates when power is supplied. The power switch is located on the side of the unit.

AEM CORD



#### B AEM CORD Amber Indicator

Illuminates if the AEM Cord is not connected to the Monitor or if the cord is not plugged into the AEM instrument.

RETURN ELECTRODE



#### C RETURN ELECTRODE Amber Indicator

Illuminates if the return electrode is of the wrong type or is not connected.

INSULATION



#### D INSULATION Red Indicator

Illuminates in the event of an internal insulation failure of an AEM Instrument.

READY



#### E READY Green Indicator

Illuminates if all conditions have been met for AEM Monitoring System operation.

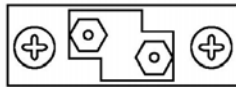

AEM® CORD

**F AEM CORD Receptacle**

The AEM Cord Adapter connects to this receptacle.



**G Green Inhibit Adapter**

An adapter that connects to the ESU return electrode receptacle and has a receptacle for the return electrode.

**Inhibit Adapter Extension** (ordered separately, as needed)

Customizes fit with various ESU return electrode receptacles



BIPOLAR ENDPOINT MONITOR

**H End Point Monitor Display**

Indicates the intensity of current flow.

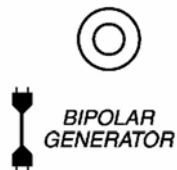

BIPOLAR GENERATOR

**I BIPOLAR GENERATOR Receptacles**

The bipolar jumper cord connects to this receptacle and to the electro-surgical generator.

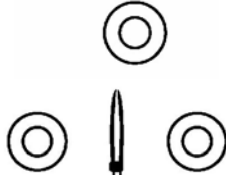

BIPOLAR ACCESSORY

**J BIPOLAR ACCESSORY Receptacles**

Connects bipolar accessories to the AEM Monitor.

## Right Side Panel

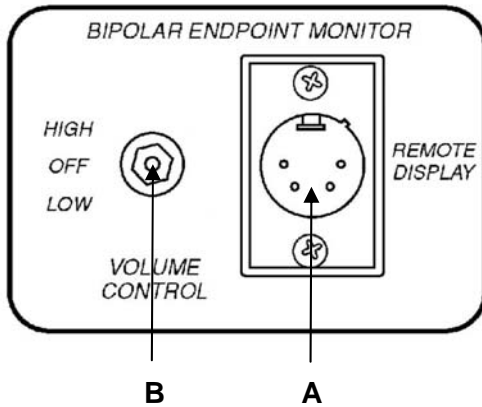

### A END POINT MONITOR REMOTE DISPLAY RECEPTACLE

Connects the End Point Monitor Remote Display (EMR) to this receptacle.

### B VOLUME CONTROL Switch

Switches between high output, low output or off.

## Left Side Panel

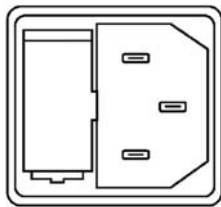

### POWER ENTRY MODULE

The power cord provided with the AEM Monitor connects to this receptacle. Fuse drawer is to the left of the connector.



POWER

### Power Switch

Rocker switch that controls power to the unit. Press "I" to activate, press "O" to turn off.

This page intentionally left blank.

---

## 3 Setup and Tests

---

### Setup of the AEM Monitoring System (Monopolar)

---

#### MOUNTING

Mount the AEM Monitor to the pedestal immediately under the electrosurgical generator so the adapter cable reaches the return electrode connector.

Using the mounting plate as a template, place it against the inside of the pedestal with the keyhole-shaped mounting holes near the top. With the top edge of the plate centered one inch below the bottom of the ESU, mark the position of the two mounting holes. Drill a 1/8 inch diameter hole at both marks. Screw an 8 X 3/8", pan-head, sheet-metal screw into each drilled hole until the head is approximately 1/8 inch from the surface. Attach the mounting plate to the rear side of the AEM Monitor using four (4) 8-32 X 3/8" flat-head screws. Hold the AEM Monitor unit so that the mounting plate is against the pedestal, and position the large portion of the mounting holes over the heads of the sheet-metal screws just installed. Push the unit flat against the pedestal and slide to the right to engage the heads of the screws in the narrow portion of the mounting holes. Tighten the screws securely.

#### **Warning**

ELECTRICAL SHOCK HAZARD. CONNECT THE POWER CORD TO A PROPERLY GROUNDED RECEPTACLE. DO NOT USE POWER PLUG ADAPTERS.

FIRE HAZARD. DO NOT USE EXTENSION CORDS.

ELECTRICAL SHOCK HAZARD. DO NOT CONNECT WET ACCESSORIES TO THE GENERATOR. ENSURE THAT ACCESSORIES AND ADAPTERS ARE CORRECTLY CONNECTED AND THAT NO METAL IS EXPOSED.

DO NOT ATTEMPT TO CONNECT OR DISCONNECT ANY CABLE DURING POWER ACTIVATION.

#### **Caution**

INSPECT ACCESSORIES AND CORDS FOR BREAKS, CRACKS, NICKS OR OTHER DAMAGE BEFORE EVERY USE. INSURE THAT END OF LIFE INDICATORS ARE NOT PRESENT. IF ANY OF THESE ARE PRESENT, DO NOT USE. FAILURE TO OBSERVE THIS PRECAUTION MAY RESULT IN INJURY OR ELECTRICAL SHOCK TO THE PATIENT OR OPERATING PERSONNEL.

CONFIRM PROPER POWER SETTINGS BEFORE PROCEEDING WITH SURGERY. USE THE LOWEST POWER SETTING POSSIBLE FOR THE MINIMUM TIME NECESSARY TO ACHIEVE THE DESIRED SURGICAL EFFECT.

---

### Notice

---

WHEN USING ES9015 UNIVERSAL ADAPTER, SEE INSTRUCTIONS FOR USE (DOCUMENT #02677).

### POWER CORD

#### Caution

CONNECT THE POWER CORD TO A WALL OUTLET HAVING THE CORRECT VOLTAGE. OTHERWISE PRODUCT DAMAGE MAY RESULT.

1. Connect the AEM Monitor power cord to a wall receptacle with the proper voltage.

### SELF-CHECK

2. Turn on the AEM Monitor. The system completes an automatic self-check. All of the visual indicators illuminate and two beeps are heard. If this is not the case, please refer to the troubleshooting section.

#### Caution

DO NOT USE THE AEM MONITOR UNLESS THE SYSTEM PROPERLY COMPLETES THE AUTOMATIC SELF-CHECK. OTHERWISE, AEM FUNCTIONS MAY NOT BE OPERATIVE.

### INHIBIT ADAPTER

---

### Notice

---

THE FOLLOWING REQUIRES THAT THE ELECTROSURGICAL GENERATOR MEET THE CONTACT RESISTANCE CRITERIA. REFER TO THE INSTRUCTIONS FOR THE ELECTROSURGICAL GENERATOR.

THE RETURN ELECTRODE USED FOR THE TESTING MUST SATISFY THE ELECTROSURGICAL GENERATOR'S CONTACT QUALITY MONITOR. EITHER PLACE THE PAD ON THE SKIN, OR ADD RESISTANCE (TYPICALLY 15 OHMS) BETWEEN THE RETURN ELECTRODE WIRES AT THE PANEL.

3. Connect the AEM Monitor inhibit adapter to the return electrode receptacle of the electrosurgical generator having compatibility with the AEM system.
4. Connect a return electrode to the AEM Monitor inhibit adapter. Verify the amber return electrode light turns off.

## **AEM CORD ADAPTER**

### **Warning**

**DO NOT TOUCH** CENTER PIN OF AEM CORD ADAPTER DURING **SET UP**. IT MAY BE **ACTIVE** IF SETUP INSTRUCTIONS ARE NOT CORRECTLY FOLLOWED.

5. Plug the cylindrical end of the AEM Cord Adapter into the ESU; plug the other end into the AEM Cord receptacle on the AEM Monitor.
6. Connect an AEM Cord with an AEM instrument to the AEM Cord Adapter at the ESU.
7. Verify that the amber AEM Cord light turns off and the green **Ready** light is on.
8. Turn on the electrosurgical generator and enable its contact quality monitoring system. It should be in its normal operational state.

**After successful completion of these steps the AEM Monitor is ready for use.**

## **Optional Functional Test for Operating Room (before procedure begins)**

An optional test to verify proper function and integrity of the instruments is described below. This test verifies that AEM instrument's internal insulation is in good condition and can be expected to perform without alerts during surgery.

1. Apply the return electrode to the patient.
2. Set the electrosurgical generator to "coag spray" or "coag fulgurate" (the highest voltage mode depending upon the generator) and set up the power level to 80 W (50 W with ConMed/Aspen Excalibur spray).
3. Next, in the sterile field,
  - Connect the instrument to the AEM Cord, so that the tip does not touch any other object.
  - Key the generator using the foot switch for approximately 3 seconds.
  - Verify that the power indicator on the generator does illuminate and that there are no AEM Monitor alerts.
  - Repeat this test on each AEM instrument.
4. Reset the power setting to the normal level.
5. Do not return any instrument giving an alert to the tray, but instead discard it or isolate it for further study. Record the type of AEM Monitor alert given: "Insulation Fault" or "AEM Cord".

Note: In the case of cord alert, the fault may be in the cord itself, the AEM Cord Adapter, or in the cord's contact with the instrument.



### Checking the Monitoring System (Monopolar)

The following is a quick test of the AEM Monitoring System. A failure on any of the following tests should be resolved before use of the system. Please refer to the troubleshooting section to establish the cause of any failure. Encision recommends that this test be performed once per year.

#### Power On Self Test Function (POST)

1. POST is activated when the power is switched on after being off for at least 30 seconds. In POST, each of the monopolar visual indicators is illuminated for 6 seconds and two beeps are heard.

#### AEM Cord Connect and Disconnect

---

##### Notice

---

THIS TEST REQUIRES THAT THE ELECTROSURGICAL GENERATOR MEET THE CONTACT RESISTANCE CRITERIA. REFER TO THE INSTRUCTIONS FOR THE ELECTROSURGICAL GENERATOR.

THE RETURN ELECTRODE USED FOR THE TESTING MUST SATISFY THE ELECTROSURGICAL GENERATOR'S CONTACT QUALITY MONITOR. EITHER PLACE THE PAD ON THE SKIN, OR ADD RESISTANCE (TYPICALLY 15 OHMS) BETWEEN THE RETURN ELECTRODE WIRES AT THE PANEL.

2. Connect the AEM Monitor inhibit adapter into the return electrode receptacle of the electrosurgical generator with a contact quality monitoring system.
3. Connect a return electrode to the AEM Monitor inhibit adapter.
4. Plug the cylindrical end of the AEM Cord Adapter into the ESU; plug the other end into the AEM Cord receptacle on the AEM Monitor.
5. Connect an AEM cord with an AEM instrument to the **AEM Cord Adapter** at the ESU.
6. Verify that the alarm indicators are off and the **Ready** indicator illuminates on the AEM Monitor.
7. Turn on the electrosurgical generator and enable its contact quality monitoring system. It should be in its normal operational state.
8. Disconnect the AEM cord from the **AEM Cord Adapter** at the ESU. Verify that the following occurs:
  - AEM Monitor **AEM Cord** indicator illuminates
  - AEM Monitor **Ready** indicator extinguishes
  - The contact quality monitoring system on the electrosurgical generator alarms

9. Reconnect the AEM cord to the **AEM Cord Adapter** at the ESU. Verify that the following occurs:
  - The AEM Monitor **AEM Cord** indicator extinguishes
  - The AEM Monitor **Ready** indicator illuminates
  - The contact quality monitoring system on the electrosurgical generator no longer signals an alarm

**Return Electrode Connect and Disconnect**

10. Verify that the alarm indicators are off and the **Ready** indicator illuminates on the AEM Monitor.
11. Disconnect the return electrode from the AEM Monitor inhibit adapter. Verify that the following occurs:
  - The AEM Monitor **Return Electrode** indicator illuminates
  - The AEM Monitor **Ready** indicator extinguishes
  - The contact quality monitoring system on the electrosurgical generator signals an alarm
12. Reconnect the return electrode from the AEM Monitor inhibit adapter. Verify that the following occurs:
  - The AEM Monitor **Return Electrode** indicator extinguishes
  - The AEM Monitor **Ready** indicator illuminates
  - The contact quality monitoring system on the electrosurgical generator no longer signals an alarm

**Active Electrode Spark to Shield Connector**

Note that the AEM Monitor may occasionally reset during the spark test (this is indicated by all the front panel lights coming on). Simply repeat the test if this occurs. Contact Encision if the problem persists. The repair policy is in section 9 of this manual.

13. Setup
  - When using the ES9005 Adapter:**  
Connect a miniature alligator clip between the two pins of the AEM Monitor **AEM Cord** receptacle.

(continued next page)

**When using the ES9015 Adapter:**

Insert any test probe into either one of the shield sockets in the hand control receptacle of the Universal Adapter (see Figure below). The socket inner diameter is approximately 2.3mm. A Tektronix ATL01, Probemaster 9100 Series Modular Test Leads and Fluke TP2 Slim Reach Test Probes are examples of probes that fit into this socket.

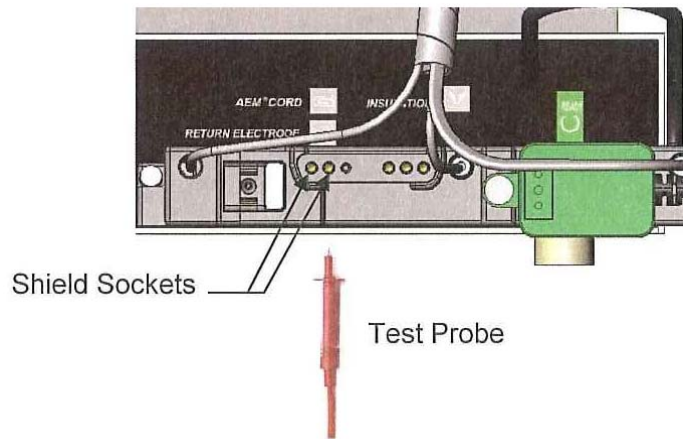

14. Connect a pencil electrode to the electro-surgical generator with a contact quality monitor. Verify that the following occurs:
  - The AEM Monitor Alarm indicator is extinguished
  - The AEM Monitor **Ready** indicator illuminates
  - The electro-surgical generator, with the contact quality monitoring system enabled, is in the normal operating state.
15. Set the electro-surgical generator with the contact quality monitoring system to 20 Watts in the standard coagulation mode.
16. Test
  - When using the ES9005 Adapter:**  
Activate the electro-surgical generator and touch the alligator clip with the pencil electrode.
  - When using the ES9015 Adapter:**  
Activate the electro-surgical generator and touch the distal end of test probe with the pencil electrode.

Verify that the following occurs:

- There is a visible spark at the active electrode
- The AEM Monitor **Ready** indicator extinguishes for ten seconds
- The AEM Monitor **Insulation** indicator illuminates for thirty seconds
- The contact quality monitoring system on the electro-surgical generator alarms
- The AEM Monitor alarms.

---

## Setup of the End Point Monitor System (Bipolar)

---

### Notice

---

IF YOU ARE USING THE ENCISION END POINT MONITOR REMOTE DISPLAY (EMR), MOUNT THE DISPLAY NEAR THE VIDEO MONITOR OR AT ANOTHER LOCATION IN THE VIEW OF THE OPERATING ROOM STAFF.

IF BOTH BIPOLAR AND MONOPOLAR FUNCTIONS ARE BEING USED, THE MONOPOLAR INSTRUMENT MUST REMAIN CONNECTED TO AVOID SPURIOUS ALARMS.

### Caution

WHEN USING THE ENCISION END POINT MONITOR REMOTE DISPLAY, ONLY THE REMOTE ILLUMINATES DURING BIPOLAR CURRENT FLOW. THE END POINT MONITOR FRONT PANEL ON THE ENCISION MONITORING SYSTEM DOES NOT ILLUMINATE.

1. Plug one end of the **Bipolar Jumper Cable** into the vertical pair of jacks on the AEM Monitor labeled **BIPOLAR GENERATOR**, the other end into the ESU bipolar output jacks.

### Warning

ELECTRICAL SHOCK HAZARD. ACCESSIBLE PINS OF THE JUMPER CORD MAY LEAD TO SHOCK OR BURNS TO SURGICAL PERSONNEL, IF THE GENERATOR BIPOLAR OUTPUT IS ACTIVATED WHILE THE BIPOLAR CORD IS PLUGGED INTO THE GENERATOR RECEPTACLE, BUT THE OTHER END IS NOT PLUGGED INTO THE AEM MONITOR RECEPTACLE.

ELECTRICAL SHOCK HAZARD. DO NOT CONNECT WET ACCESSORIES TO THE GENERATOR. ENSURE THAT ACCESSORIES AND ADAPTERS ARE CORRECTLY CONNECTED AND THAT NO METAL IS EXPOSED.

### Caution

INSPECT ACCESSORIES AND CORDS FOR BREAKS, CRACKS, NICKS OR OTHER DAMAGE BEFORE EVERY USE. INSURE THAT END OF LIFE INDICATORS ARE NOT PRESENT. IF ANY OF THESE ARE PRESENT, DO NOT USE. FAILURE TO OBSERVE THIS PRECAUTION MAY RESULT IN INJURY OR ELECTRICAL SHOCK TO THE PATIENT OR OPERATING PERSONNEL.

2. Prepare the surgical instrument to be used for the procedure. Connect one end of the bipolar instrument cord to the instrument and the other end into the **Bipolar Accessory** receptacle on the left front panel of the AEM Monitor.
3. Adjust the volume of the clicks that indicate bipolar current flow. The **Volume Control** switch is located on the right side panel of the AEM Monitor.

### Caution

THE END POINT MONITOR ACTIVATION CLICKS WHEN AN ACCESSORY IS ACTIVE. DO NOT TURN THE VOLUME DOWN TO WHERE THE CLICKING SOUND IS BELOW AN AUDIBLE LEVEL.

4. Adjust the bipolar output mode and power setting.

### Caution

CONFIRM PROPER POWER SETTINGS BEFORE PROCEEDING WITH SURGERY. USE THE LOWEST POWER SETTING POSSIBLE FOR THE MINIMUM TIME NECESSARY TO ACHIEVE THE DESIRED SURGICAL EFFECT.

5. After successful completion of these steps, the bipolar activation tone on the bipolar generator sounds and the system is ready for operation. In operation, the bipolar indicator bar illuminates, indicating the current flowing between tines.

### Warning

DO NOT ATTEMPT TO CONNECT OR DISCONNECT ANY CABLE DURING POWER ACTIVATION.

## Checking the End Point Monitoring System (Bipolar)

---

The response of the End Point Monitor may be tested during use.

1. Set the generator at 5 to 10 watts (depending upon the generator characteristics).
2. Touch the tines of the instrument together. There should be a smooth registration of the current on the bar-graph scale. The clicking will also change its rate in correspondence with the current.

When performing this check for the first time with a particular bipolar generator, start at a low setting, then increase the setting to obtain a mid scale deflection of the bar-graph. This test ensures that all three components (cord, bipolar instrument and End Point Monitor) are functional.

## Mechanical Inspection

---

The AEM Monitor and End Point Monitor require minimal maintenance. It is recommended that the AEM Monitor be inspected by qualified service personnel at least twice a year. This inspection should include the list below. Periodically, the following list should be checked.

### Warning

ELECTRIC SHOCK HAZARD. GROUND NUT MUST BE SECURE.

- Ground nut properly secured to ground post.
- No evidence of damage on insulation of wiring and cable.
- Connectors and cables are fully seated.
- All hardware is securely fastened.
- AEM Monitor / End Point Monitor system check.

## Electrical Inspection

---

**Verification of the End Point Monitor display:** Encision recommends that this test be performed once per year.

1. Connect the End Point Monitor to any compatible electrosurgical generator with a continuously adjustable output (not digital) in series with a noninductive load resistor between 50 ohms ( $\Omega$ ) and 200 ohms and a reference meter.
2. The reference meter should have a true RMS response, a band width of at least 10 MHz and an accuracy of 1%.
3. Agreement between the End Point Monitor and the reference meter should be within 10% of full scale with currents between 600 mA and 1000 mA.

### Cleaning

---

#### Warning

ELECTRIC SHOCK HAZARD. ALWAYS UNPLUG THE AEM MONITOR BEFORE CLEANING.

(NOTE: CLEAN MONITOR WHEN NEEDED.)

1. Turn off the AEM Monitor.
2. Disconnect all accessories.
3. Follow the procedures approved by your institution or use a validated infection control procedure.
4. Use a mild cleaning solution or disinfectant and a damp cloth to thoroughly wipe all outside surfaces and the power cord.

#### Notice

---

DO NOT ALLOW FLUIDS TO ENTER THE CHASSIS.

DO NOT CLEAN THE AEM MONITOR WITH ABRASIVE CLEANING OR DISINFECTANT COMPOUNDS, SOLVENTS, OR OTHER MATERIALS THAT COULD SCRATCH THE PANELS OR DAMAGE THE UNIT.

DO NOT STEAM STERILIZE THE AEM MONITOR.

### Storing the AEM Monitor

---

The AEM Monitor should be stored within these parameters:

- Temperature: -13 to 158° F (-25 to 70° C)
- Humidity: 5% to 95% relative, non-condensing

If you store the AEM Monitor at a temperature that is outside its normal operating range of 50 to 122° F (10 to 50° C), allow one hour for the monitor to reach room temperature before use.

### Service Center

---

Encision Inc.  
6797 Winchester Circle  
Boulder, Colorado 80301-3513 USA

(303) 444-2600

[www.encision.com](http://www.encision.com)

## 4 Troubleshooting

This troubleshooting guide gives instructions for identifying and correcting malfunctions and responding to alarms. Refer to Section 8 if a part needs to be replaced.

### Caution

REFER ALL SERVICING TO QUALIFIED PERSONNEL.

### AEM Monitor (Monopolar)

Situation	Possible Cause	Recommended Action
The Power On Self Test function (POST) did not take place when power was turned ON. <b>All</b> indicators including the power ON are not on, and no beeps are heard.	Disconnected power cord, faulty wall receptacle, or faulty power cord.	Check the power cord connections (monitor and wall receptacle). Connect the power cord to a functional wall receptacle. If necessary replace the power cord.
	Fuse drawer is open or fuses are blown.	Open the fuse drawer. Check the fuses and replace, if necessary, with 0.5 A, 5 X 20 mm fuse. Install the fuse drawer.
	Malfunctioning power entry module or connections.	Check the power entry module and its cable connections, if faulty, contact service center.
	Malfunctioning power switch.	Test switch, if faulty, replace power switch.
	Malfunctioning AC Power cable (in chassis).	Measure line voltage at input terminals on J1 of power supply. If the line voltage is not present, replace AC power cable.
	Malfunctioning power supply.	Check the power supply's output voltages at power supply's J2: Pins 2 and 4 are ground; Pin 1, + 15.0 $\pm$ .1V; Pin 3, +5.27 $\pm$ .05V; Pin 5, -15.0 $\pm$ .1V. If any voltage is incorrect, adjust or replace power supply.
	Internal cables loose, disconnected, or malfunctioning.	Check and reseal all internal connections. Turn on and measure the power supply voltages at J4 on the ESM Main Board. If any voltage is incorrect, replace DC power cable.



## Troubleshooting

---

Situation	Possible Cause	Recommended Action
The self test function (POST) did not take place when power was turned on. Power <b>On</b> indicator is on.	Malfunctioning power supply.	Check the power supply's output voltages at power supply's J2: Pins 2 and 4 are ground; Pin 1, + 15.0 $\pm$ .1V; Pin 3, +5.27 $\pm$ .05V; Pin 5, -15.0 $\pm$ .1V.  If any voltage is incorrect, adjust or replace the power supply.
	Internal cables loose, disconnected, or malfunctioning.	Check and reseal all internal connections. Turn on and measure the power supply voltages at J4 on the ESM Main Board. If any voltage is incorrect, replace the DC power cable.
	ESM Main Board malfunction.	Turn the power switch <b>Off</b> for 30 seconds, and then turn <b>On</b> . If the problem persists, return the unit for repair.
	Front Panel malfunction.	If the above steps have failed, return the unit for repair.

Situation	Possible Cause	Recommended Action
<p>Electrosurgical generator remains in alarm state. <b>AEM Cord</b> indicator is on.</p>	<p>Poor connection of the cord to the shield or Active Electrode Monitor.</p>	<p>Disconnect and reconnect the cord connection to the instrument and the cord connection to the Active Electrode Monitor.</p>
	<p>Malfunctioning cord.</p>	<p>Connect the cord to the instrument and put the probes of an ohm meter to the pin sockets in the Active Electrode Monitor AEM cord connector. If the resistance is &gt;4 Ohms, replace the cord.</p>
	<p>Malfunctioning connection to ESM Main Board.</p>	<p>Short the pins in the <b>AEM Cord</b> receptacle (on the front panel). If the indicator doesn't go out, remove the cover and short pins 1 &amp; 2 of J1. If the indicator goes out, replace the shield connector assembly.</p>
	<p>Malfunctioning ESM Main Board.</p>	<p>Remove the front panel connection to the ESM Main Board at J2 and connect a voltmeter shunted with 1K ohms to the +15V supply (+ end of C47) and pin U2-16. The voltage should be &gt;14V initially, and &lt;1V when pins 1 &amp; 2 are shorted. If this does not happen, return the unit for repair.</p>
	<p>Malfunctioning ESM Display Board.</p>	<p>If the above steps have failed, return the unit for repair.</p>

## Troubleshooting

---

Situation	Possible Cause	Recommended Action
<p>Electrosurgical generator remains in alarm state.</p> <p><b>Return Electrode</b> indicator is on.</p>	<p>Improper return electrode.</p> <p>Dual Electrode pin is not being detected.</p> <p>Malfunctioning connection to ESM Main Board.</p> <p>Defective ESM Main Board.</p> <p>Defective ESM Display Board.</p>	<p>Must use a dual-pad return electrode. Verify that the return electrode connector has a pin projecting from the end.</p> <p>Remove the return electrode connector from the adapter and reinsert fully into the adapter. If the <b>Return Electrode</b> indicator goes out, unit is OK. If not, wiggle the return electrode connector in the direction of smallest dimension. If the indicator goes out only momentarily, replace the adapter assembly.</p> <p>Remove the cover and short pins 3 &amp; 4 of J1. If the indicator goes out, replace the adapter assembly.</p> <p>Remove the front panel connection to the ESM board at J2 and connect a voltmeter shunted with 1K ohms to the +15V supply (+ end of C47) and pin U2-15. The voltage should be &gt;14V initially, and &lt;1V when pins 3 &amp; 4 are shorted. If this does not happen, return the unit for repair.</p> <p>If the above steps have failed, return the unit for repair.</p>
<p>Electrosurgical generator remains in alarm state.</p> <p>Both <b>Return Electrode</b> and <b>AEM Cord</b> indicators are on.</p>	<p>See possible causes for both "<b>Return Electrode</b> indicator is on" and "<b>AEM Cord</b> indicator is on."</p>	<p>See recommended action for both "<b>Return Electrode</b> indicator is on" and "<b>AEM Cord</b> indicator is on."</p>

Situation	Possible Cause	Recommended Action
<p>Electrosurgical generator remains in alarm state.</p> <p><b>Ready</b> indicator is on and all fault indicators are off.</p>	<p>Electrosurgical generator in alert state.</p>	<p>Reset the electrosurgical generator contact quality monitor.</p>
	<p>Dual pad open or short circuited.</p>	<p>Install dual pad so that correct resistance is seen by the electrosurgical generator.</p>
	<p>Poor connection in return electrode circuit.</p>	<p>Disconnect and reconnect return electrode connection to the adapter and the adapter connection to the electrosurgical generator.</p>
	<p>Malfunctioning electrosurgical generator.</p>	<p>Plug the return electrode connector directly into the electrosurgical generator. If the electrosurgical generator still shows an alarm status, replace the electrosurgical generator.</p>
	<p>Malfunctioning connection to ESM Main Board.</p>	<p>Short pins on either side of the Adapter (only 1 short). Measure the resistance between the corresponding pins on the other side. If &gt;2 ohms, add short between pins 5 &amp; 6 of J1. If still &gt; 2 ohms, return the unit for repair.</p>
<p>Malfunctioning ESM Main Board.</p>	<p>Remove all connections to the adapter, and measure the resistance between pins 5 &amp; 6 of J1. If &gt;2 ohms, return the unit for repair.</p>	

## Troubleshooting

---

Situation	Possible Cause	Recommended Action
Electrosurgical generator not in alert state during fault. The <b>Ready</b> indicator is off, and any of the following indicators are also on: <b>AEM Cord, Return Electrode</b> , or <b>Insulation</b> .	Inappropriate internal state of the AEM Monitor.	Turn power switch <b>Off</b> for 30 seconds, then <b>On</b> . Retry operation. If the <b>Ready</b> indicator is still inappropriately lighted, continue with tests.
	Malfunctioning electrosurgical generator.	Remove the adapter from the electrosurgical generator, if it does not go into a contact quality alert, replace the electrosurgical generator.
	Malfunctioning connection to ESM Main Board.	Remove the adapter from the ESU, disconnect P1 from J1 and measure the resistance between pins 5 & 6 of P1. If < 2 ohms, replace the adapter assembly.
	Defective ESM Main Board.	Disconnect P1 from J1 and measure the resistance between pins 5 & 6 of J1. If < 2 ohms, return the unit for repair.
	Malfunctioning ESM Display Board.	If the above steps have failed, return the unit for repair.



### End Point Monitor (Bipolar)

Situation	Possible Cause	Recommended Action
When the power is turned ON, <b>all</b> indicators including the power ON are not on, and no beeps are heard.	Disconnected power cord, faulty wall receptacle, or malfunctioning power cord.	Check the power cord connections (Monitor and wall receptacle). Connect the power cord to a functional wall receptacle. If necessary replace the power cord
	Fuse drawer is open or fuses are blown.	Open the fuse drawer. Check the fuses and replace, if necessary, with 0.5A, 5 X 20 mm fuse. Install the fuse drawer.
	Malfunctioning power entry module or connections.	Check the power entry module and its cable connections; if faulty, repair or replace the power entry module.
	Malfunctioning power switch.	Test the switch; if faulty, replace the power switch.
	Malfunctioning AC Power Cable (in chassis).	Measure the line voltage at input terminals on J1 of the power supply. If a line voltage is not present, replace the AC power cable.
	Malfunctioning power supply.	Check the power supply's output voltages at power supply's J2: Pins 2 and 4 are ground; Pin 1, + 15.0 $\pm$ .1V; Pin 3, +5.27 $\pm$ .05V; Pin 5, -15.0 $\pm$ .1V. If any voltage is incorrect, adjust or replace the power supply.
	Internal cables loose, disconnected, or faulty.	Check and reseal all internal connections. Turn on and measure the power supply voltages at J4 on the ESM Main Board. If any voltage is incorrect, replace DC power cable. Measure power supply voltages at J4 on the EPM Main Board. If any voltage is incorrect, replace I/F Cable.
	Malfunctioning ESM Display Board.	If the above steps have failed, return the unit for repair.

Situation	Possible Cause	Recommended Action
No bar graph indication.	End Point Monitor Remote plugged into the End Point Monitor.	Verify that nothing is plugged into the <b>Remote Display</b> connector located on the rear of the End Point monitor.
	Malfunctioning power supply.	Check the power supply's output voltages at power supply's J2: Pins 2 and 4 are ground; Pin 1, + 15.0 $\pm$ .1V; Pin 3, +5.27 $\pm$ .05V; Pin 5, -15.0 $\pm$ .1V.  If any voltage is incorrect, adjust or replace the power supply.
	Internal cables loose, disconnected, or malfunctioning.	Check and reseal all internal connections. Turn on and measure the power supply voltages at J4 on the ESM Main Board. If any voltage is incorrect, replace the DC power cable. Measure power supply voltages at J4 on the EPM Main Board. If any voltage is incorrect, replace the I/F Cable.
	Malfunctioning connection between Front Panel receptacles and EPM Main Board.	Measure the resistance between the upper <b>Bipolar Generator</b> receptacle and the right-most <b>Bipolar Accessory</b> receptacle. Measure the resistance between the lower <b>Bipolar Generator</b> receptacle and the left-most <b>Bipolar Accessory</b> receptacle while pins 1 & 2 of J1, of the EPM Main Board are being shorted. If any of the above measurements is > 2 ohms, replace the front panel.



## Troubleshooting

---

Situation	Possible Cause	Recommended Action
continued...	Malfunctioning EPM Main Board.	Connect the electrosurgical generator bipolar output to the <b>Bipolar Generator</b> receptacle by using 2 banana cords. Short the <b>Bipolar Accessory</b> receptacle with another banana cord. Set the bipolar output power to approximately 3 watts. Connect a DC voltmeter across J3 pin 1 & 2. If the voltmeter does not show an indication when the electrosurgical generator is activated, return the unit for repair.
	Malfunctioning EPM Display Board.	If the above steps have failed, return the unit for repair.
No audible indication (no clicking), correct bar graph indication.	The <b>Volume Control</b> switch is in the wrong position.	Set the <b>Volume Control</b> switch to the up position, <b>High</b> .
	Malfunctioning speaker, speaker <b>Volume Control</b> switch, and/or cable.	Measure the voltage between ground (- end of C6) and the end of R22 nearest the board edge. If it is < 4.8 V, return the unit for repair (assuming the ESM Main Board is OK). Set the speaker <b>Volume Control</b> switch to <b>High</b> . Remove the meter end of the lead connected to R22 and momentarily touch it to ground. Perform the above test with the <b>Volume Control</b> switch set to <b>Low</b> and again in <b>Off</b> . If a click is not heard from the speaker while the switch is in either <b>High</b> or <b>Low</b> , replace the volume control switch.
	Malfunctioning EPM Main Board.	Connect the electrosurgical generator bipolar output to the <b>Bipolar Generator</b> receptacle using 2 banana cords. Short the <b>Bipolar Accessory</b> receptacle with another banana cord. Set the bipolar output power to approximately 3 watts and the <b>Volume Control</b> switch to <b>High</b> . If a clicking is not heard when the electrosurgical generator is activated, return the unit for repair.

<b>Situation</b>	<b>Possible Cause</b>	<b>Recommended Action</b>
<p>“Fuzzy” Indication on the bar graph. When indicating near the high end of the current scale, the bars at the right end of the indication are neither fully on nor off.</p>	<p>Faulty power supply.</p>	<p>Check the power supply’s output voltages at power supply’s J2:            Pins 2 and 4 are ground;            Pin 1, + 15.0 ±.1V;            Pin 3, +5.27 ±.05V;            Pin 5, -15.0 ± .1V.</p> <p>If any voltage is incorrect, adjust or replace the power supply.</p>
	<p>Internal cables loose, disconnected, or malfunctioning.</p>	<p>Check and reseal all internal connections. Turn on and measure power supply voltages at J4 on the ESM Main Board. If any voltage is incorrect, replace DC power cable. Measure power supply voltages at J4 on the EPM Main Board. If any voltage is incorrect, replace I/F Cable.</p>
	<p>Malfunctioning EPM Display Board or EPM Main Board.</p>	<p>If the above steps have failed, return the unit for repair.</p>

## Troubleshooting

---

Situation	Possible Cause	Recommended Action
Front panel display does not turn off when End Point Monitor Remote is plugged into rear connector.	Malfunctioning EPM Main Board.	Connect the electrosurgical generator bipolar output to the <b>Bipolar Generator</b> receptacle using 2 banana cords. Short the <b>Bipolar Accessory</b> receptacle with another banana cord. Set the bipolar output power to approximately 3 watts. Remove the remote connector and short pins 6 & 7 in J3. If the front panel bar graph still shows an indication when the electrosurgical generator is activated, return the unit for repair.
	Internal cables loose, disconnected, or malfunctioning.	Connect the electrosurgical generator bipolar output to the <b>Bipolar Generator</b> receptacle using 2 banana cords. Short the <b>Bipolar Accessory</b> receptacle with another banana cord. Set the bipolar output power to approximately 3 watts. Remove remote connector and short pins 1 & 2 in the remote connector receptacle. If the front panel bar graph still shows an indication when the electrosurgical generator is activated, return the unit for repair.
	Malfunctioning End Point Monitor Remote unit.	Measure the resistance between pins 1 & 2 of the remote display's plug. If >2 ohms, replace the End Point Monitor Remote unit.

Situation	Possible Cause	Recommended Action
<p>End Point Monitor Remote Display does not indicate when plugged into the AEM Monitor and the front panel display works properly when the plug is removed.</p>	<p>Defective EPM Main Board.</p>	<p>Remove the remote connector. Measure the supply voltage between pins 7 (ground) &amp; 4 of J3. Connect the electrosurgical generator bipolar output to the <b>Bipolar Generator</b> receptacles using 2 banana cords. Short the <b>Bipolar Accessory</b> receptacles with another banana cord. Set the bipolar output power to cause an indication in the upper half of the scale. Activate the electrosurgical generator and measure the voltage between pin 7 (ground) and pin 5 &amp; 6 of J3. If the voltage difference is &gt;0.1V and the supply voltage &gt;5.20V, return the unit for repair.</p>
	<p>Internal cables loose, disconnected or malfunctioning.</p>	<p>Remove the remote connector. Measure the supply voltage between pins 1 &amp; 4 of the remote connector receptacle. Connect the electrosurgical generator's bipolar output to the <b>Bipolar Generator</b> receptacles using 2 banana cords. Short the <b>Bipolar Accessory</b> receptacles with another banana cord. Set the bipolar output power to cause an indication in the upper half of the scale. Activate the electrosurgical generator and measure the voltage between pin 1 (ground) and pin 2 &amp; 3 of the remote connector receptacle. If the voltage difference is &gt;0.1V and the supply voltage &gt;5.20V, return the unit for repair.</p>
	<p>Defective End Point Monitor Remote unit.</p>	<p>If the above steps have failed, replace the End Point Monitor remote unit.</p>

This page intentionally left blank.

## 5 Principles of Operation

The AEM Monitor is divided into two separate functional parts: the AEM Monitor portion and the End Point Monitor portion. The implementation for each of these functions is independent of the other, with the exception of the power supply and enclosure.

### Theory of Operation—AEM (Monopolar)

The AEM Monitoring System enhances safety by detecting insulation breakdowns and blocking stray currents that may not be detected by the surgeon during electrosurgical procedures. Indicators identify “Set up” and “Operative” alarms so that the proper corrective action can be taken.

During minimally invasive procedures, monopolar electrosurgery has safety and performance issues that differ from those of open procedures.

The safety of the patient depends, in part, on the quality of electrical insulation on the extended electrodes, and the amount of current which is conducted through the insulation due to capacitance. These potential electrical problems are compounded by the fact that only a small portion of the total length of the insulation may be viewed by the surgical team.

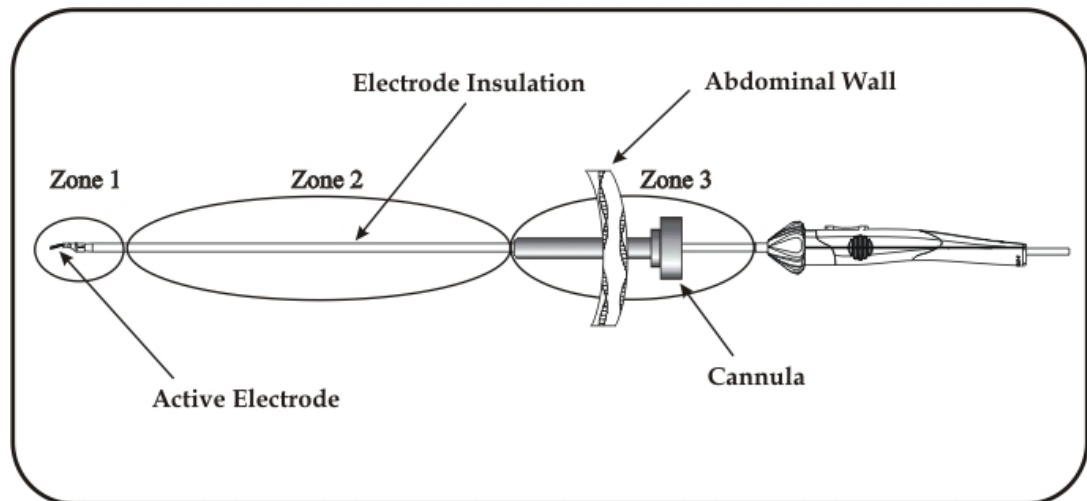

Zones 2 & 3 are likely out of the surgeon's field of view.

## Principles of Operation

Electrosurgical equipment produces high voltage radio-frequency energy. These high voltages require insulation on the electrodes to eliminate the flow of current except at the tip. Normal wear and tear of the instruments may degrade the insulation, and such defects may be outside of the normal field of view. Consequently, a failure capable of causing harm may go unnoticed.

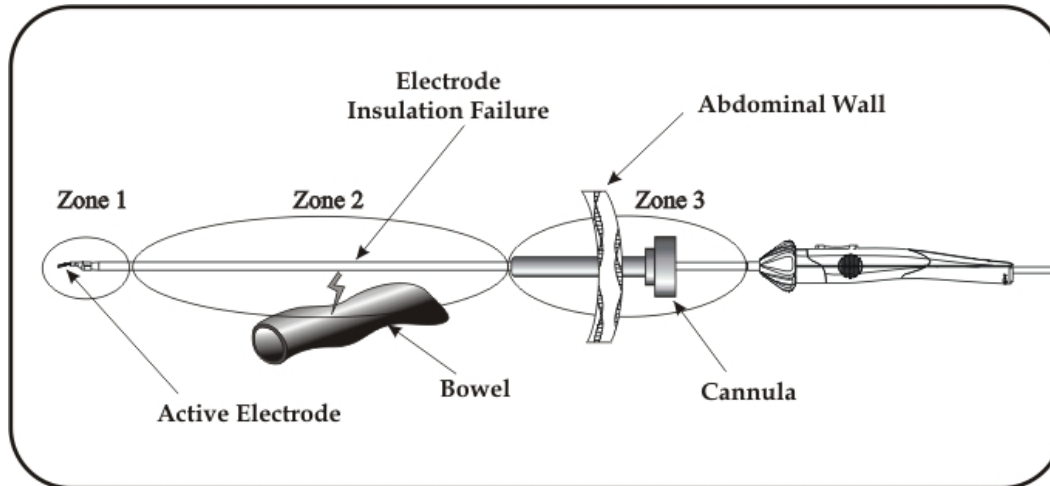

Capacitively coupled currents also have the potential for causing burns. The radio frequency energy used in electrosurgery will flow between closely spaced conductors even though there is no direct connection between them. The active electrode and a metallic cannula are closely spaced conductors, and they form a capacitor which can conduct radio frequency current. Testing has shown that 5% to 40% of the power indicated on the electrosurgical generator may be delivered from a metallic insulated trocar sheath to the patient's tissues. This amount of power is enough to cause a serious burn quickly.

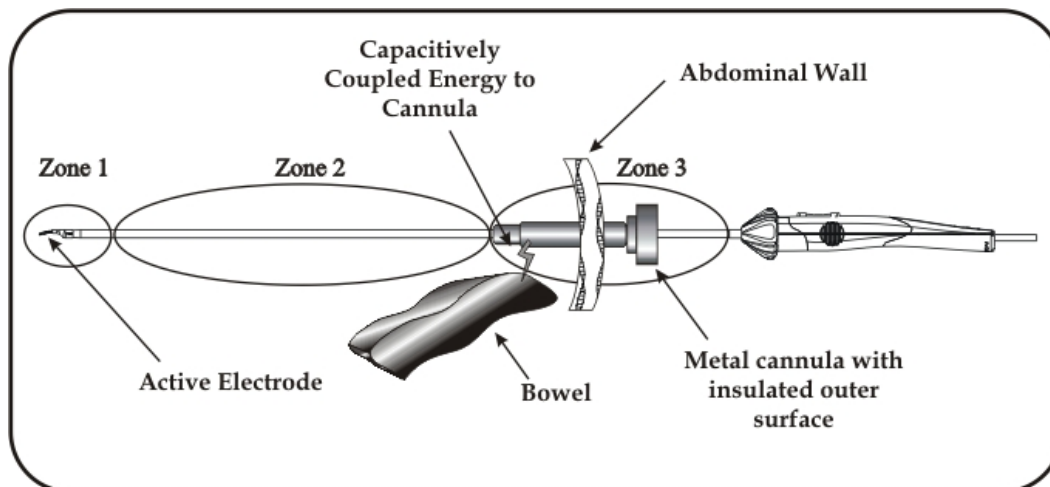

AEM instruments, in conjunction with an AEM Monitor properly connected to the electrosurgical generator (ESU), continuously monitor and dynamically manage "stray energy" (insulation failure and capacitive coupling) in zones 2 & 3, AEM shielding does not cover zone 1, which the surgeon should keep in view during instrument activation.

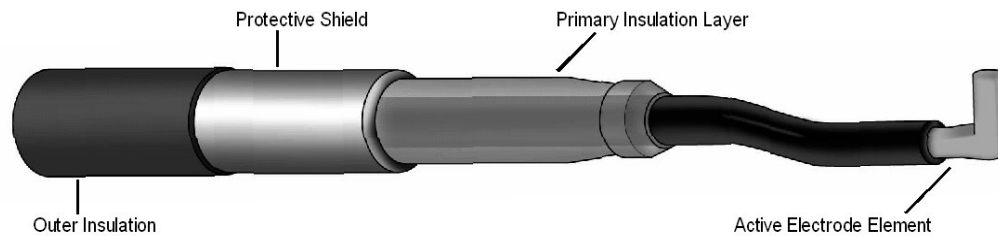

The AEM instruments incorporate a layered design. AEM instruments are shielded and monitored to prevent stray electrosurgical burns along the shaft of the instrument caused by insulation failure or capacitive coupling. The protective shield built into all AEM instruments provides a neutral return path for capacitively coupled energy and protection from insulation failure. The shield is continuously monitored during surgery which provides continuous assurance of the integrity of the instrument.

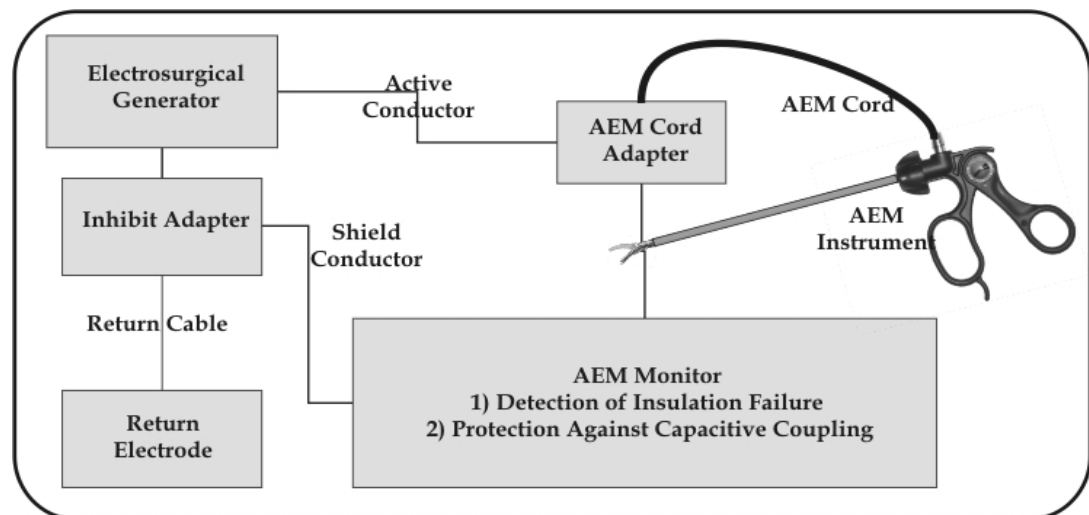

The AEM Monitor measures the currents flowing in the AEM integrated instruments, detects faults in the insulation, and monitors the connections of the shield and the return electrode. The AEM Monitor includes an inhibit adapter which connects between the electrosurgical generator and the return electrode. When an insulation or connection fault is detected, the AEM Monitor interrupts the contact quality monitor circuit of the electrosurgical generator. In the event of an insulation fault, an alarm sounds and a visual indicator illuminates. The normal response of the generator to the contact quality circuit interruption is inhibition of radio frequency energy output.

### Notice

THE PEAK OPEN CIRCUIT VOLTAGE PRODUCED BY THE ELECTROSURGICAL GENERATOR MAY BE SLIGHTLY REDUCED WHEN IT IS USED WITH THE AEM SYSTEM. NORMALLY THE VOLTAGES PRODUCED UNDER LOADED CONDITIONS ARE NOT SIGNIFICANTLY ALTERED.



### **Circuit Operation (Monopolar)**

---

The Block Diagram shown on page 5-5 shows several functional blocks. Each block (shown in a dotted enclosure) will show how the subfunctions are grouped in the current implementation. The circuit descriptions of each of these blocks are described in this section.

#### **ESM Adapter Relay**

The adapter places the AEM Monitor relay electrically between the return electrode and the electrosurgical unit (ESU). The relay contact is used to place the ESU in normal or inhibit function depending on the results of the AEM Monitor measurements. When the contact is opened, the AEM Monitor signals the ESU to inhibit because the contact quality monitor within the ESU measures high impedance. The adapter also contains a switch which is actuated by a feature on the return electrode connector. A switch activates a setup fault in the presence of the wrong type of electrode. This ensures the connection of the correct type of return electrode. A conductivity monitor reads the state of the switch.

#### **ESM Current Monitor**

To determine the status of electrode insulation, the AEM Monitor measures two aspects of the current flowing in the conductive shield that encloses the insulation. Criteria are placed on the measurements and the results of the two measurements, are passed to the logic section for alarm generation if required.

The first criterion which must be met is that the current measured over its total band width must be less than a preset value. Currents above this value generate an alert. The value at which the alarm generates varies with the waveform used, but is typically between 350 and 400 mA rms for cutting waveforms. Currents of this magnitude or higher are produced at typical control settings when the active electrode is shorted to the shield. The T2 current transformer with R14 produces a voltage signal proportional to the shield current. U8 forms a full-wave rectifier with U10 differentially amplifying the filtered result yielding a current magnitude signal. U9B then compares this magnitude with a preset value determined by R57 and R58 and the results of this comparison are input to the logic section.

The second current criterion involves a filtered component of the current centered around a frequency which is well below the principle frequency of electrosurgical waveforms. When the magnitude of this component of current exceeds a predetermined fraction of the magnitude of the wide band current, an alarm is generated. This typically happens when a spark is generated between an active conductor and the shield, and that may occur over the entire range of generator coagulation control settings. U3 forms a 3-pole filter for the current signal. U5 detects the filtered signal, with U10A amplifying it and U9A performing the comparison.

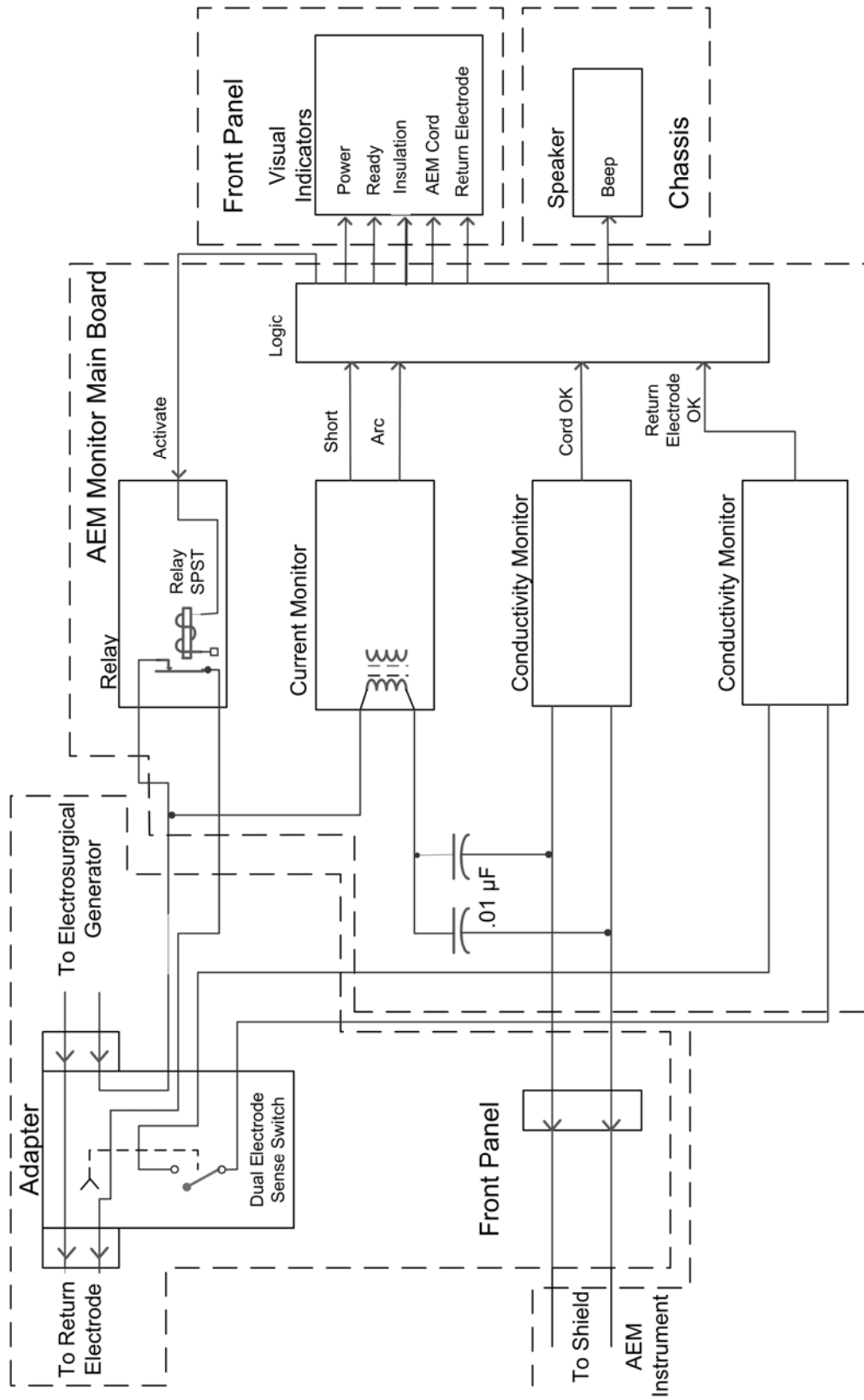

BLOCK DIAGRAM, ESM AEM MONITOR

### ESM Conductivity Monitors

The conductivity monitors sense the circuit resistance in the AEM Monitor circuit and the dual electrode sense switch circuit. When the circuit resistance is less than approximately 50 ohms the circuit outputs a positive logic level signal. When greater circuit resistance is present, the circuit outputs a low logic level signal. The circuit outputs are isolated from the inputs. The AEM Monitor block diagram is found in Section 10. Drawings and Schematics may be requested by contacting Encision Technical Support (303-444-2600). Both of the conductivity monitors operate in the same way.

The monitor circuitry includes U1A and the surrounding components, and the optical isolator IS01. Resistors R8 and R10 form one leg of a bridge and R9, R72 and the external circuit resistance form the other leg of the bridge. The amplifier in U1A functions as a null detector. When the external circuit resistance is less than the null point, the amplifier output at pin 1 will be high allowing all of the current out of R1 to flow through the diode of the optical isolator. When the external circuit resistance is greater than the null point, the amplifier shunts all of the current out of R1 around the diode. When the optical isolator diode is conducting, the isolator transistor is also conducting, which pulls the output voltage to near 5 volts. When the diode is not conducting, the transistor is not conducting, causing the output voltage to be near ground. These transitions are briefly delayed to the logic input buffer (U6-7) by R74 and C34. The buffer output drives the Programmable Logic Device (PLD) logic input (U4-5). R74 and C34 also serve to suppress the effects of RF pickup as well as R72, C49, and C5.

The conductivity monitors described above are isolated from the circuit ground used by the other circuits. Consequently, the conductivity monitors must be powered by an isolated power supply. The primary side of transformer T1 is driven by a FET (Q1) whose input is connected to the system's 8 kHz, square-wave clock. The output appearing at the secondary winding of T1, is rectified by diode D2, filtered by C1 and C4, and regulated to approximately 4 volts by Zener D1.

### Logic

The Logic Circuitry controls the functioning of the unit in response to sensors measuring external parameters, such as: **AEM Cord** connected, **Patient Electrode** connected, Active electrode short or arcing to Shield. The responses include activating: front panel indicators, audible indications, and the control relay. The Logic Circuitry is shown in the schematic, ESM, Logic drawing.

The logic is paced by the system clock whose frequency is controlled to approximately 8.2 kHz by precision RC components (R38, R39, C27) and a clock IC (U7). This primary frequency is counted down by a counter chain in U7 to form square-wave outputs of 512 Hz, 2 Hz, and 0.5 Hz. These outputs are applied to logic inputs of the PLD (U4) at pins 8, 9, and 10, respectively.

The Power-On Detector generates a 50 ms, positive logic pulse "PON" when the power has just been turned on after being off for more than 5 seconds. When the system power is off, C32 is discharged. When the system power is turned on, the juncture of C32 and R37 will be at a positive voltage nearly equal to the +5V supply, this causes the output of U6A to go positive. Then C32 will charge

to the supply voltage through R37. When the voltage across C32 becomes large enough, the buffer amplifier U6A turns off and its output goes to zero. Resistors R36 and R35 cause positive feedback to be applied so that the transitions will be quick. Diode D5 prevents the input to U6A from being damaged by negative input caused when the power is turned off, and C55 is intended to eliminate RF interference.

The functional logic is determined by the PLD in U4 (GAL6001). Logic input signals are buffered by the amplifiers in U6 to ensure proper logic levels. The logic output signals are buffered by the amplifiers in U2 to supply sufficient sink current as required by the output indicators.

The functional logic implemented by the PLD is described below. The “PON” signal causes a reset of the time counter and all internal counters and starts the Power On System Test (POST) cycle. A six-bit counter, implemented with buried flip-flops, counts the 2 Hz clock input and is used to time the various actions.

Each of the indicators is driven by a separate PLD output. During the POST cycle, all indicators are turned on to test the indicator circuitry. The **AEM Cord** indicator is controlled by the “CORDS” signal which indicates whether the cord is in place. The **Return Electrode** indicator is controlled by the “REF” signal which indicates whether the return electrode connector is plugged into the adapter. The **Insulation** indicator illuminates when either the “SHORT” or “ARC” signals are present and remains on for 30 seconds after activation. The “SHORT” signal indicates that the current being drained by the shield exceeds a predetermined threshold, and the “ARC” signal indicates that there is an arc to the shield. In addition, the meaning of the **AEM Cord** and **Insulation** indicators are changed when the unit is in a debug mode. This mode is active when the AEM Cord is in place while the return electrode is unplugged, thus causing the **AEM Cord** indicator to illuminate when a short is detected (“SHORT” signal) and the **Insulation** indicator to illuminate when an arc is detected (“ARC” signal). The **Ready** indicator illuminates when the ESM Adapter Relay is closed.

The ESM Adapter Relay is driven by its own PLD output and it is closed when none of the fault conditions mentioned above are present and after five seconds of an **Insulation** fault. The ESM Adapter Relay is open during the POST cycle.

The beep is created by driving a speaker with a 512 Hz square wave signal that is gated by the PLD logic to cause 0.5 second beeps separated by a 0.5 second pause at the required times. Two beeps are generated at the end of the POST cycle and one beep is generated when an **Insulation** fault is detected followed by three beeps five seconds later.

### Visual Indicators

The visual indicators are LEDs located on the front panel. The power **On** illuminates from the -15 V supply, the **AEM Cord**, **Return Electrode**, **Insulation**, and **Ready** indicators are powered by the +15 V supply and controlled by the Logic circuitry.

### Aural Indicator

A small speaker is mounted on the rear panel of the chassis and it produces the beep for the AEM Monitor alarms and a click for the End Point Monitor changes.

### **Theory of Operation - End Point Monitoring System**

---

The surgeon may use the End Point Monitor (a radio-frequency (RF) ammeter) to aid in determining the end point of bipolar electrosurgical desiccation.

Desiccation is a process whereby heat is dissipated in tissue, and the electrolytic fluid is driven away. As desiccation takes place the electrical impedance of the tissue and the flow of current changes. A bar-graph displays the current calibrated in tenths of an ampere. As the current changes, the frequency of clicks changes.

Use the End Point Monitor in conjunction with visual, tactile, temporal, and aural information observed during surgery. The surgeon must use all the information presented and interpret it with reference to experience to determine that desiccation is satisfactorily completed. Thus, it is important not to draw conclusions about the completion of desiccation from the indications of the End Point Monitor alone.

### **Circuit Operation (Bipolar)**

---

The Block Diagram shown on page 5-9 shows several functional blocks. Each block (shown in a dotted enclosure) will show how the subfunctions are grouped in the current implementation. The circuit descriptions of each of these blocks are described in this section.

#### **RMS to DC Convertor**

The ESU waveforms used vary over a wide range of shapes. Thus the heating value of the current or RMS is the signal conversion method of choice. This allows the ammeter display to read a value which is closely related to the surgical effect the surgeon is seeking. T1 in combination with R4 and R5 provide a voltage proportional to the instantaneous electrosurgical current. U1 provides a heating (root-mean-squared) conversion of this signal to U2 which amplifies and scales the signal to a level which is appropriate to drive the display. Gain calibration is inherent and controlled by the precision devices U1 and U2 in combination with 1% resistors R 7, 9, 10, 11. The offset is set by R13.

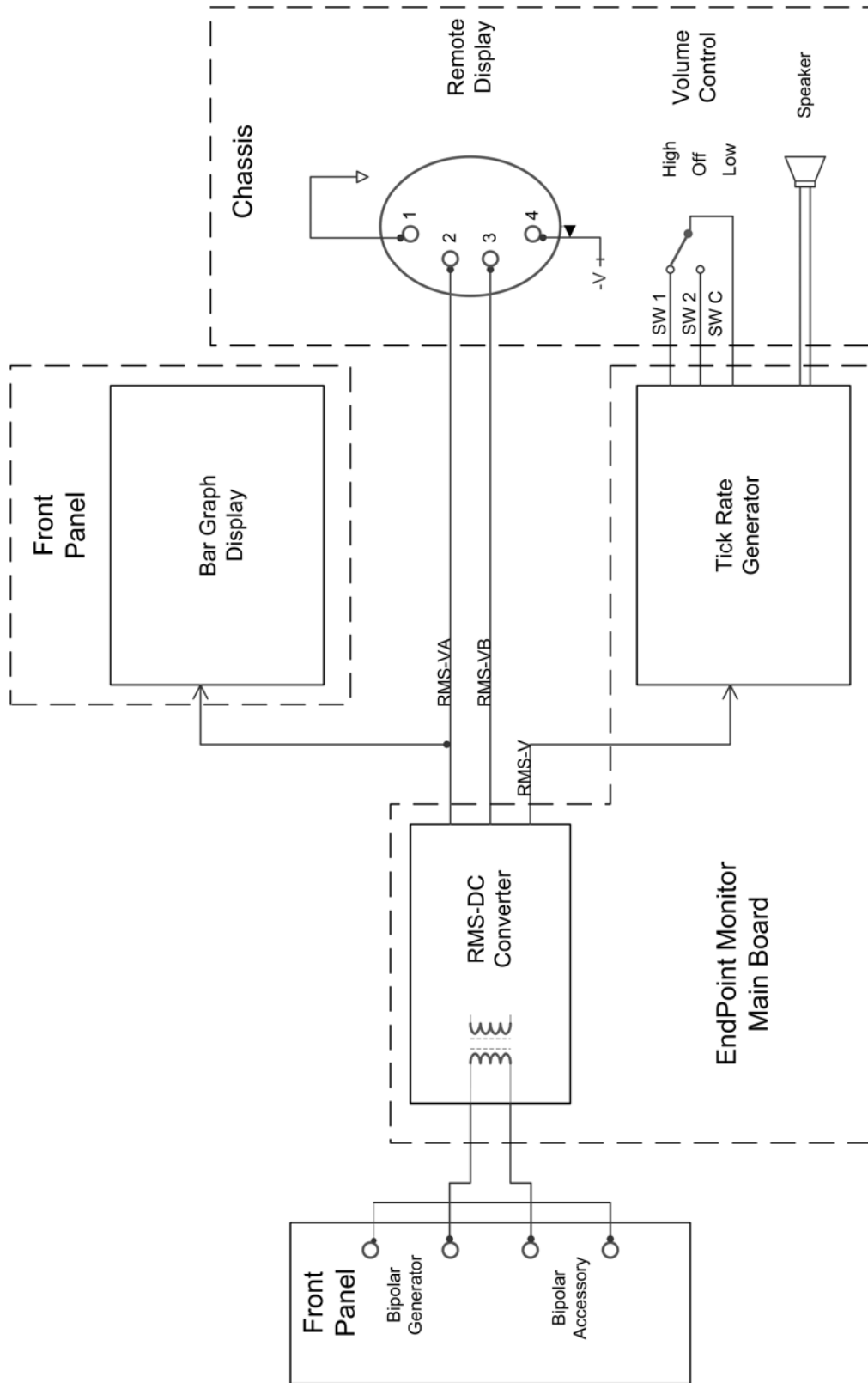

BLOCK DIAGRAM, EPM AEM MONITOR

### Tick Rate Generator

U2C and U4D form a current source converting the input voltage signal to a current signal. A current mirror comprised of U4C,D refers the current to the +15V supply. U3 is an oscillator whose frequency is dependant upon the charging current applied to C21. The discharge of C21 is through R24 resulting in discharge time short compared to the charge time. U4A and Q1 form an amplifier to drive the speaker from the oscillator output. The short discharge of C21 causes a "tick" to be heard from the speaker.

### Bar-graph Display

LED bar-graphs U1-3 form a 30 segment display. U4-6 are a comparator array which convert an analog input to the appropriate switch closures and current source to form a bar whose length is proportional to the magnitude of the current. Offset and gain are inherent in the function of the ICs U4-6 and are accommodated by the RMS to DC convertor. Segment intensity is controlled by the values of R1, R3, and R5.

---

## 6 Surgical Use

---

### Before Surgery

---

The AEM Monitor should be mounted to the pedestal immediately under the electrosurgical generator so the adapter cable reaches the return electrode connector.

The Monitoring System is intended to be used with the electrosurgical generator in electrosurgical mode only.

#### Warning

FIRE HAZARD. DO NOT USE EXTENSION CORDS.

ELECTRIC SHOCK HAZARD. CONNECT THE POWER CORD TO A PROPERLY GROUNDED RECEPTACLE. DO NOT USE POWER PLUG ADAPTERS.

ELECTRIC SHOCK HAZARD. DO NOT ATTEMPT TO CONNECT OR DISCONNECT ANY CABLE DURING POWER ACTIVATION.

#### Caution

CONNECT THE POWER CORD TO A WALL OUTLET HAVING THE CORRECT VOLTAGE. OTHERWISE PRODUCT DAMAGE MAY RESULT.

DO NOT USE THE AEM MONITOR UNLESS THE SYSTEM PROPERLY COMPLETES THE AUTOMATIC SELF-CHECK. OTHERWISE, AEM FUNCTIONS MAY NOT BE OPERATIVE.

1. Connect the AEM Monitor power cord to a wall receptacle with the proper voltage.
2. Turn on the AEM Monitor. The system completes an automatic self-check. All of the visual indicators illuminate and two beeps are heard. If this is not the case, please refer to the "Troubleshooting" section.



### Monopolar Surgery

---

Active electrode monitoring is intended to control stray monopolar energy caused by insulation failure and capacitive coupling on the shaft of the AEM instrument.

#### Caution

THE ACTIVE ELECTRODE MONITORING SYSTEM TECHNOLOGY IS DESIGNED TO SAFELY DELIVER ELECTROSURGICAL ENERGY AND TO PREVENT INJURY CAUSED BY INSULATION FAILURE AND CAPACITIVE COUPLING. THE AEM MONITOR IS NOT INTENDED TO TEST FOR INSULATION DAMAGE ON LAPAROSCOPIC INSTRUMENTS. DO NOT ATTEMPT TO USE THIS SYSTEM AS AN INSTRUMENT INSPECTION TOOL.

GOOD OPERATING ROOM PRACTICE SUGGESTS THAT CONNECTIONS OF ACCESSORIES TO ELECTROSURGICAL GENERATORS BE MADE ONLY WHILE GENERATOR IS *OFF* OR ON *STANDBY*.

#### Power On Self Test Function (POST)

POST is activated when the power is switched on after being off for at least 30 seconds. In POST, each of the monopolar visual indicators illuminates for six seconds and two beeps are heard.

#### Setup

---

1. Connect the AEM Monitor inhibit adapter to the return receptacle on the electrosurgical generator.
2. Apply the return electrode to the patient, and plug it into the inhibit adapter already mounted into the electrosurgical unit's return electrode receptacle.
3. Plug AEM Cord Adapter into footswitch output of ESU.

#### Caution

AEM WILL NOT FUNCTION WITHOUT THE USE OF A DUAL PAD RETURN ELECTRODE AND AN ELECTROSURGICAL UNIT EQUIPPED WITH CONTACT QUALITY MONITORING PATIENT SAFETY TECHNOLOGY.

READ AND REVIEW ALL INSTRUCTIONS PROVIDED BY THE MANUFACTURER OF THE DUAL PAD RETURN ELECTRODE YOU WILL BE USING.

READ AND REVIEW ALL INSTRUCTIONS PROVIDED BY THE MANUFACTURER OF THE AEM ACCESSORIES YOU WILL BE USING.

ONLY AN AEM INSTRUMENT PROVIDES ACTIVE ELECTRODE MONITORING. OTHER CONDUCTIVE OBJECTS AT OR NEAR THE SURGICAL SITE ARE NOT PROTECTED. DO NOT TOUCH THOSE OBJECTS WITH THE ACTIVE INSTRUMENT.

4. Connect an AEM cord with an AEM instrument to the **AEM CORD ADAPTER** at the ESU.

---

## Checking the AEM Monitoring System

---

The following is a quick test of the AEM Monitoring System. A failure of this test should be resolved before using the system. Please refer to the Troubleshooting Section to establish the cause of any failure.

5. Verify that the setup fault indicators are off and the **READY** indicator illuminates on the AEM Monitor.
6. Turn on the electrosurgical generator and enable its contact quality monitoring system. It should be in its normal operational state.
7. Disconnect the AEM Cord from the **AEM CORD ADAPTER** at the ESU. Verify that the following occurs:
  - The AEM Monitor **AEM CORD** indicator illuminates.
  - The AEM Monitor **READY** indicator extinguishes.
  - The contact quality monitoring system on the electrosurgical generator alarms.
8. Reconnect the AEM Cord to the **AEM CORD** Adapter at the ESU. (Reset the contact quality monitoring system if necessary.) Verify that the following occurs:
  - The AEM Monitor **AEM CORD** indicator extinguishes.
  - The AEM Monitor **READY** indicator illuminates.
  - The contact quality monitoring system on the electrosurgical generator no longer alarms.

After successful completion of these steps, the system is ready for use. If the system does not perform as described, do not use until repaired and refer to Section 4, Troubleshooting.

## Bipolar Surgery

---

End Point Monitoring of the bipolar instrument will assist the surgeon in confirming the end point of bipolar desiccation. This information is displayed on the left front panel of your AEM Monitor as an illuminated visual graph and a volume controlled audible indicator. If you are using the Encision End Point Monitor Remote Display (EMR), plug it into the receptacle found on the right side panel of the AEM Monitor.

---

### Notice

---

IF YOU ARE USING THE ENCISION END POINT MONITOR REMOTE DISPLAY (EMR), MOUNT THE DISPLAY NEAR THE TV MONITOR OR AT ANOTHER LOCATION IN THE VIEW OF THE OPERATING ROOM STAFF.

IF BOTH MONOPOLAR AND BIPOLAR FUNCTIONS ARE BEING USED, THE MONOPOLAR INSTRUMENT MUST REMAIN CONNECTED TO AVOID SPURIOUS ALARMS.

WHEN USING THE ENCISION END POINT MONITOR REMOTE DISPLAY (EMR), ONLY THE REMOTE ILLUMINATES DURING BIPOLAR CURRENT FLOW. THE END POINT MONITOR FRONT PANEL ON THE AEM MONITOR DOES NOT ILLUMINATE.

---

### Setup

---

1. Plug the bipolar jumper cord into the receptacle marked **Bipolar Generator** on the left front panel of the AEM Monitor and the other end into the bipolar receptacle of the electrosurgical generator.

### Warning

**ELECTRIC SHOCK HAZARD.** ACCESSIBLE PINS OF THE JUMPER CORD MAY LEAD TO SHOCK OR BURNS TO SURGICAL PERSONNEL, IF THE GENERATOR BIPOLAR OUTPUT IS ACTIVATED WHILE THE BIPOLAR JUMPER CORD IS PLUGGED INTO THE GENERATOR RECEPTACLE, BUT THE OTHER END IS NOT PLUGGED INTO THE AEM MONITOR RECEPTACLE.

**ELECTRIC SHOCK HAZARD.** DO NOT CONNECT WET ACCESSORIES TO THE GENERATOR. ENSURE THAT ACCESSORIES AND ADAPTERS ARE CORRECTLY CONNECTED AND THAT NO METAL IS EXPOSED.

INSPECT ACCESSORIES AND CORDS FOR BREAKS, CRACKS, NICKS OR OTHER DAMAGE BEFORE EVERY USE. VERIFY THAT END OF LIFE INDICATORS ARE NOT PRESENT. IF ANY OF THESE ARE PRESENT, DO NOT USE. FAILURE TO OBSERVE THIS PRECAUTION MAY RESULT IN INJURY OR ELECTRICAL SHOCK TO THE PATIENT OR OPERATING PERSONNEL.

2. Prepare the surgical instrument to be used for the procedure. Connect one end of the bipolar instrument cord to the instrument and the other end into the receptacle marked **Bipolar Accessory** on the left front panel of the AEM Monitor.
3. Adjust the volume of the clicks that indicate bipolar current flow. The **Volume Control** switch is located on the left right side panel of the AEM Monitor.

**Caution**

THE END POINT MONITOR ACTIVATION CLICKS WHEN AN ACCESSORY IS ACTIVE. DO NOT TURN THE VOLUME DOWN TO WHERE THE CLICKING SOUND IS BELOW AN AUDIBLE LEVEL.

4. Adjust the bipolar output mode and power setting on the generator.

**Caution**

CONFIRM PROPER POWER SETTINGS BEFORE PROCEEDING WITH SURGERY. USE THE LOWEST POWER SETTING POSSIBLE FOR THE MINIMUM TIME NECESSARY TO ACHIEVE THE DESIRED SURGICAL EFFECT.

5. After successful completion of these steps, the bipolar activation tone on the bipolar generator sounds upon keying and the system is ready for operation. In operation, the bipolar indicator bar illuminates, indicating the current which is flowing between tines.

**Warning**

ELECTRIC SHOCK HAZARD. DO NOT ATTEMPT TO CONNECT OR DISCONNECT ANY CABLE DURING POWER ACTIVATION.

**Checking the End Point Monitoring System**

---

The response of the End Point Monitor may be tested during use.

1. Set the generator at 5 to 10 watts (depending upon the generator characteristics).
2. Touch the tines of the instrument together. There should be a smooth registration of the current on the bar graph scale. The clicking will also change its rate to correspond with the current.

When performing this check for the first time with a particular bipolar generator, start at a low setting, then increase the setting to obtain a mid scale deflection of the bar graph. This test ensures that all three components (cord, bipolar instrument and End Point Monitor) are functional.

## **General Precautions**

### **Return Electrode**

---

#### **Warning**

AEM MONITORING IS INTENDED FOR USE ONLY WITH ELECTROSURGICAL GENERATORS INCORPORATING CONTACT QUALITY MONITORING IN CONJUNCTION WITH A DUAL PAD TYPE RETURN ELECTRODE. REFER TO MANUFACTURER'S INSTRUCTIONS.

### **Active Accessories**

---

#### **Warning**

THESE DEVICES HAVE BEEN SPECIFICALLY DESIGNED FOR USE IN ELECTROSURGERY. DO NOT USE FOR OTHER PROCEDURES.

ELECTRIC SHOCK HAZARD. DO NOT ATTEMPT TO CONNECT OR DISCONNECT ANY CABLE DURING POWER ACTIVATION.

DO NOT WRAP ACCESSORY CORDS AROUND METAL OBJECTS. WRAPPING CORDS AROUND METAL OBJECTS MAY INDUCE CURRENTS THAT COULD LEAD TO SHOCKS, FIRES OR INJURY.

THE ELECTRODE TIP MAY REMAIN HOT ENOUGH TO CAUSE BURNS AFTER THE ELECTROSURGICAL CURRENT IS DEACTIVATED.

WHEN NOT IN USE, PLACE ACCESSORIES IN A CLEAN, DRY, NONCONDUCTIVE AND HIGHLY VISIBLE AREA NOT TOUCHING THE PATIENT. INADVERTENT CONTACT WITH THE PATIENT MAY RESULT IN BURNS.

INADVERTENT ACTIVATION OR MOVEMENT OF THE ACTIVATED ELECTRODE TIP OUTSIDE THE FIELD OF VISION MAY RESULT IN INJURY TO THE PATIENT. USE THESE INSTRUMENTS ONLY UNDER CONDITIONS THAT ASSURE ADEQUATE VISUALIZATION.

IF ELECTRODES ARE TOUCHING OTHER INSTRUMENTS, DO NOT ACTIVATE THEM BECAUSE UNINTENDED TISSUE DAMAGE MAY OCCUR.

CONTACT OF THE ACTIVE ELECTRODE WITH ANY METAL (SUCH AS HEMOSTATS AND CLAMPS) WILL GREATLY INCREASE CURRENT FLOW AND CAN RESULT IN UNINTENDED BURN INJURY.

WHEN USING LAPAROSCOPIC INSTRUMENTATION WITH METAL CANNULAS, THE POTENTIAL EXISTS FOR ABDOMINAL WALL BURNS TO OCCUR IN THE EVENT OF DIRECT ELECTRODE TIP CONTACT TO THE CANNULA.

REFER TO THE CANNULA MANUFACTURER'S INSTRUCTIONS BEFORE INSERTING THE ELECTRODE INTO THE CANNULA. TO AVOID DAMAGING THE ELECTRODE OR INJURING THE PATIENT, INSERT AND WITHDRAW THEM CAREFULLY.

INSPECT CORDS FOR BREAKS, CRACKS, NICKS OR OTHER DAMAGE BEFORE EVERY USE. ENSURE THAT END OF LIFE INDICATORS ARE NOT PRESENT. IF ANY OF THESE ARE PRESENT, DO NOT USE. FAILURE TO OBSERVE THIS PRECAUTION MAY RESULT IN INJURY OR ELECTRICAL SHOCK TO THE PATIENT OR OPERATING PERSONNEL.

**Warnings, continued...**

DAMAGED EXTERNAL INSULATION ON INSTRUMENTS AND INCORRECT SETUP OF THE AEM MONITOR MAY RESULT IN A RISK OF UNINTENDED PATIENT BURN. DO NOT USE PRODUCT HAVING DAMAGED INSULATION.

**Caution**

READ THE INSTRUCTIONS, WARNINGS, AND CAUTIONS PROVIDED WITH THE AEM MONITORING SYSTEM ACCESSORIES BEFORE USING. THEIR SPECIFIC INSTRUCTIONS ARE NOT INCLUDED IN THIS MANUAL.

LIMIT POWER SETTING TO 80 WATTS OR LOWER (60 WATTS FOR THE CONMED ASPEN EXCALIBUR SPRAY MODE). HIGHER SETTINGS MAY RESULT IN SPURIOUS INSULATION FAILURE ALARMS AND/OR INSULATION BREAKDOWN. REFER TO INSTRUMENT INSTRUCTIONS FOR USE FOR OTHER LIMITS.

DAMAGED INTERNAL INSULATION OF THE INSTRUMENT, OR LOSS OF SHIELD CONTINUITY, MAY CAUSE ESU RETURN PAD ALARMS TRIGGERED BY THE AEM MONITOR'S FAULT INDICATORS. FOR MAXIMUM PATIENT SAFETY, DISCONTINUE USE OF THE INSTRUMENT IF THIS OCCURS.

A SINGULAR AEM INSTRUMENT MUST BE THE SOLE CONDUCTOR OF ENERGY TO TISSUE. DO NOT CONDUCT ENERGY BY TOUCHING AN AEM INSTRUMENT TO A SECOND INSTRUMENT CONTACTING TISSUE. THE SECOND DEVICE WILL NOT BE PROTECTED FROM CAPACITIVE COUPLING AND INSULATION FAILURE.

---

**Responding to Monitor Alarms**

---

When using AEM Monitoring, successful electrosurgery depends upon an absence of any critical fault conditions. Should one develop, the AEM Monitoring System disables the attached electrosurgical generator, with contact quality monitor, from further functioning until you correct the alarm condition.

The AEM Monitor extinguishes its **READY** indicator and illuminates one or more of the alarm indicators.

**RETURN ELECTRODE Amber Alarm Indicator (SETUP FAULT)**

- Check that the return electrode connector is securely connected into the AEM Monitor inhibit adapter and the inhibit adapter is connected to the return electrode receptacle of the electrosurgical generator with contact quality monitoring.
- If both connections have been made and the amber indicator continues to illuminate, replace the return electrode.

### **AEM CORD** Amber Alarm Indicator (**SETUP FAULT**)

- Check the AEM cord to ensure that it is securely connected to the front panel receptacle marked **AEM CORD** and that the other end is connected to an AEM integrated instrument.
- If both connections are made and the amber indicator continues to illuminate, replace the AEM cord.

### **INSULATION** Red Alarm Indicator (**OPERATIVE FAULT**)

#### **Warning**

ILLUMINATION OF A RED **INSULATION** INDICATOR INDICATES AN UNSAFE ACTIVE ACCESSORY AND DEACTIVATES THE ELECTROSURGICAL GENERATOR. THE **INSULATION** INDICATOR REMAINS ON FOR 30 SECONDS AND THE GENERATOR IS INHIBITED FOR 10 SECONDS FOLLOWING A BEEP FROM THE AEM MONITORING SYSTEM.

- Replace both the instrument and Encision shield or integrated AEM instrument, whichever is appropriate.
- If the **INSULATION** indicator continues to illuminate, use a backup AEM Monitor to complete the surgical procedure.

If for any reason an AEM alarm continues from your AEM Monitor, use a backup AEM Monitor to complete the surgical procedure.

### **Preparing the AEM Monitor for Reuse**

---

1. Turn off the AEM Monitor.
2. Disconnect all accessories.

#### **Warning**

ELECTRIC SHOCK HAZARD. ALWAYS UNPLUG THE AEM MONITOR BEFORE CLEANING.

3. Follow the procedures approved by your institution or use a validated infection control procedure. Use a mild cleaning solution or disinfectant and a damp cloth to thoroughly wipe all surfaces and the power cord.

#### **Notice**

---

DO NOT ALLOW FLUIDS TO ENTER THE CHASSIS.

DO NOT CLEAN THE AEM MONITOR WITH ABRASIVE CLEANING OR DISINFECTANT COMPOUNDS, SOLVENTS, OR OTHER MATERIALS THAT COULD SCRATCH THE PANELS OR DAMAGE THE UNIT.

DO NOT STEAM STERILIZE THE AEM MONITOR.

## 7 Technical Specifications

---

All specifications are subject to change without notice.

### Operating Modes - AEM Monitoring

---

#### POST Mode

The **POWER ON SELF TEST** function (POST) activates each time you turn on the AEM Monitor after the monitor has been OFF for 30 seconds. In POST, each of the indicators illuminates for six seconds and two tones sound.

#### Monopolar Operating Mode

The AEM Monitor detects improper setup conditions and detects operative faults by providing a monitored pathway for the current which is flowing from the shield to the patented return electrode. Fault conditions are indicated on the front panel and the electrosurgical generator is signaled to disable its output. Operative faults also generate an audible alarm.

#### Bipolar Operating Mode

The AEM Monitor measures the RF current flowing between the elements of a bipolar accessory. A number of segments on the display illuminate corresponding to the magnitude of current flowing between the tines of the accessory. The indicated current range is 0.1 A to 1.1 A. The AEM Monitor clicks at a rate proportional to the indicated current and the click volume is adjustable to high, low, and off. A remote visual display may be plugged into the monitor and placed in a convenient viewing position.



## Functional Characteristics

---

### Monopolar Setup Fault Detection

If the shield or return electrode are disconnected, causing a setup fault, a yellow indicator illuminates to identify the deficiency and the AEM Monitor opens one side of the return electrode circuit causing the electrosurgical generator to detect a pad fault and disable its output.

### Shield Cable and Return Electrode Switch Threshold

50 ohms  $\pm$  20%

### Monopolar Operative Fault Detection

If there is excessive shield current or arcing between the shield and the active electrode causing an operative fault, a red indicator illuminates to identify an insulation fault, an audible alarm is generated, and the AEM Monitor opens one side of the return electrode circuit causing the electrosurgical generator to detect a pad fault and disable its output.

### Radio Frequency Current Sensing

Current-sensing and spark detection are provided. Minimum electrosurgical generator output for reliable insulation fault detection: 20 Watts

### Bipolar Current Measurement

The number of segments illuminated in the bar-graph display corresponds to the magnitude of the bipolar current. In addition to the visual display, the AEM Monitor generates clicks at a rate proportional to the measured current and the click volume is adjustable to high, low, or off.

Accuracy: 10% of full scale

Range: 0.1 to 1.1 Ampere

Maximum current without damage: 3.0 Amperes

Click Rate: 25 to 40 Hz at 1.0 Ampere

### Remote Bipolar Current Indication

An End Point Monitor Remote Display (EMR) is available which can be placed in a convenient viewing position. The Encision End Point Monitor Remote Display (EMR) indicates the same information as the front panel display, but when the Encision End Point Monitor Remote Display (EMR) is plugged into the **REMOTE DISPLAY** connector, the front panel display is inactive.

Cord Length: 15' (4.6 m)

Duty Cycle: Continuous

## Indicators and Alert Functions

---

### Setup Fault Indicators

**AEM CORD**, yellow light

Indicates that the AEM Cord, AEM cord adapter, or the instrument is not properly connected to the AEM Monitor.

**RETURN ELECTRODE**, yellow light

Indicates that the return electrode is not properly connected, the adapter is malfunctioning, or that a dual pad electrode is not being used.

### Operative Fault Indicators

**INSULATION**, red light

Indicates that there is excessive current or arcing between the active electrode and the shield. Once triggered, the insulation light stays on for 30 seconds. Immediately upon detection of fault, one beep; after approximately 4 seconds, 3 beeps. The audio volume is fixed and cannot be turned off.

### Status Indicators

**POWER**, green light

Indicates that the AEM Monitor is plugged in and turned on.

**READY**, green light

Indicates that there are no faults and that the electrosurgical generator can be activated. Stays off for ten seconds after operative fault.

### Bipolar Current Indicators

**RF AMPERES**

30 segment bar-graph display

The number of segments illuminated in the bar-graph display corresponds to the magnitude of the bipolar current as indicated on the scale underneath.

Audible Indication, adjustable volume clicks. The clicks are delivered at rate proportional to indicated current.

## Connectors and Cables

---

### AEM CORD

Connects the AEM Instrument active conductor to the electrosurgical generator and shield conductors to the AEM Monitor, both via the AEM Cord Adapter.

Length:

10.5' (3.2 m) standard reusable cord

9.5' (2.9 m) standard disposable cord

**Inhibit Adapter**, green block attached by means of a cable to front panel,

Cable length: 21" (53 cm)

Dual-area Return Electrode plug on one face which connects to the electrosurgical generator.

Dual-area Return Electrode receptacle on opposite face which connects to Return Electrode plug attached to the actual return electrode. Senses the pin of a dual area return electrode.

### **AEM CORD receptacle on front panel**

A unique, two-conductor receptacle that receives the AEM Cord Adapter or Universal Adapter.

There is no preferred polarity.

### **BIPOLAR GENERATOR jacks**, two arranged vertically on front panel

Two standard banana jacks.

Provided for connecting to the bipolar electrosurgical generator.

There is no preferred polarity.

### **Bipolar Jumper Cord**, dual banana plugs on each end of a cord

Provided for connecting the AEM Monitor to the bipolar electrosurgical generator.

There is no preferred polarity.

### **BIPOLAR ACCESSORY jacks**, two arranged horizontally on front panel

Two standard banana jacks.

Provided for connecting to the bipolar accessory.

There is no preferred polarity.

### **REMOTE DISPLAY jack**, mounted on right side panel

Four pin, male, XLR series, panel receptacle.

Provided for connecting to the remote display cable. Attaching the cable activates the remote display and deactivates the front panel display of bipolar current.

### **Power Receptacle**, mounted on left side panel

UL/IEC type receptacle containing two, 0.5 A, 250V, fast blow, 5 × 20 mm fuses (one for each side of the line).

### **Power Cord**, attached to power receptacle

A 15' (4.6 m) long, 16/3 power cord with a three-prong hospital-grade plug.

## Electrical Characteristics

---

### Input Power Requirements 115 Volt

115 V~ nominal  
105 - 130 Volts ~, 47 - 63 Hz  
Normal current drain 0.2 A  
Maximum current 0.5 A

### Chassis Source Leakage Current

100  $\mu$ A maximum

### Patient Leakage Current

Source or sink leakage current is 10  $\mu$ A maximum

## Dimensions and Weight

---

### External Dimensions

13.0" (33.0 cm) wide x 9.36" (23.7 cm) long x 7.20" (18.3 cm) high (does not include feet). Feet raise chassis 0.5" (1.3 cm).

Weight: 8.9 lbs (4.04 kg)

## Environmental Characteristics

---

### Operating Temperature

50 to 122<sup>o</sup> F (10 to 50<sup>o</sup> C)

### Storage and Transport Temperature

-13 to 158<sup>o</sup> F (-25 to 70<sup>o</sup> C)

### Operating, Storage and Transport Humidity

5% to 95% relative, non-condensing

### Atmospheric Pressure (Operating, Storage and Transport)

50 - 110 kPa

## Standards and IEC Classifications

### Class I Equipment per IEC 60601-1/EN 60601-1

Protection against electrical shock is provided by connection of accessible conductive parts to the protective ground conductor in such a way that they cannot become live in the event of a failure of basic insulation.

### Type CF Equipment per IEC 60601-1/EN 60601-1

The Active Electrode Monitor provides a high degree of protection against electrical shock, particularly regarding allowable leakage currents, and has a CF type isolated (floating) applied part.



Caution



Type CF equipment with defibrillator protection



Protective Earth (Ground)

### Notice

ORDINARY EQUIPMENT IS NOT PROTECTED AGAINST THE INGRESS OF WATER.

MEDICAL ELECTRICAL EQUIPMENT NEEDS SPECIAL PRECAUTIONS REGARDING EMC AND NEEDS TO BE INSTALLED AND PUT INTO SERVICE ACCORDING TO THE EMC INFORMATION PROVIDED HEREIN.

PORTABLE AND MOBILE RF COMMUNICATIONS EQUIPMENT CAN AFFECT MEDICAL ELECTRICAL EQUIPMENT

### Electromagnetic emissions and immunity per IEC 60601-1-2/EN 60601-1-2

<b>Manufacturer's declaration – electromagnetic emissions (EN 60601-1-2:2002 Table 201)</b>		
The Encision Model EM2 series AEM Monitor and accessories are intended for use in the electromagnetic environment specified below. The customer or user of the equipment should assure that it is used in such an environment.		
Emissions test	Compliance	Electromagnetic environment - guidance
RF emissions CISPR 11	Group 1	The Model EM2 series AEM Monitor and accessories uses RF energy only for its internal function. Therefore, its RF emissions are very low and not likely to cause any interference with nearby electronic equipment.
RF emissions CISPR 11	Class A	The Model EM2 series AEM Monitor and accessories is suitable for use in all establishments other than domestic and those directly connected to the public low-voltage power supply network that supplies building used for domestic purposes.
Harmonic emissions IEC 61000-3-2	Class A	
Voltage fluctuations/ flicker emissions IEC 61000-3-3	Complies	

<b>Manufacturer's declaration – electromagnetic immunity (EN 60601-1-2:2002 Table 202)</b>			
The Encision Model EM2 series AEM Monitor and accessories are intended for use in the electromagnetic environment specified below. The customer or user of the equipment should assure that it is used in such an environment.			
Immunity test	IEC 60601 test level	Compliance level	Electromagnetic environment - guidance
Electrostatic discharge (ESD)  IEC 61000-4-2	±6kV contact ±8 kV air	±6 kV contact ±8 kV air	Floors should be wood, concrete or ceramic tile. If floors are covered with synthetic material, the relative humidity should be at least 30%.
Electrical fast transient/burst IEC 61000-4-4	±2kV for power supply lines ±1kV for input/output lines	±2kV for power supply lines ±1kV for input/output lines	Mains power quality should be that of a typical commercial or hospital environment.
Surge IEC 61000-4-5	±1kV line(s) to line(s) ±2kV line(s) to earth	±1kV line(s) to line(s) ±2kV line(s) to earth	Mains power quality should be that of a typical commercial or hospital environment.
Voltage dips. Short Interruptions and voltage variations on power supply input lines IEC 61000-4-11	<5%U <sub>T</sub> (>95% dip in U <sub>T</sub> ) for 0.5 cycle 40% U <sub>T</sub> (60% dip in U <sub>T</sub> ) for 5 cycles 70% U <sub>T</sub> (30% dip in U <sub>T</sub> ) for 25 cycles <5% U <sub>T</sub> (>95% dip in U <sub>T</sub> ) for 5 s	<5%U <sub>T</sub> (>95% dip in U <sub>T</sub> ) for 0.5 cycle 40% U <sub>T</sub> (60% dip in U <sub>T</sub> ) for 5 cycles 70% U <sub>T</sub> (30% dip in U <sub>T</sub> ) for 25 cycles <5% U <sub>T</sub> (>95% dip in U <sub>T</sub> ) for 5 s U <sub>T</sub> = 230VAC 50Hz and 110VAC 50Hz	Mains power quality should be that of a typical commercial or hospital environment. If the user of the Model EM2 series AEM Monitor and accessories requires continued operation during power mains interruption, it is recommended that the Model EM2 series AEM Monitor and accessories be powered from an uninterruptible power supply or a battery.
Power frequency (50/60Hz) magnetic field IEC 61000-4-8	3 A/m	50 and 60Hz, 3 A/m	Power frequency magnetic fields should be at levels characteristic of a typical location in a typical commercial or hospital environment.

<b>Guidance and manufacturer's declaration – electromagnetic immunity (EN 60601-1-2-2002 Table 204)</b>			
The Encision Model EM2 series AEM and accessories are intended for use in the electromagnetic environment specified below. The customer or user of the equipment should be sure that it is used in such an environment.			
<b>Immunity test</b>	<b>IEC 60601 test level</b>	<b>Compliance level</b>	<b>Electromagnetic environment – guidance</b>
Conducted RF IEC 61000-4-6	3 Vms 150kHz to 80 MHz	3 Vms 150kHz to 80 MHz	Portable and mobile RF communications Equipment should be used no closer to any part of the Model EM2 series AEM Monitor and accessories, including cables, than the recommended separation distance calculated from the equation applicable to the frequency of the transmitter.  Recommended separation distance $d = 1.2 \sqrt{P}$ 80 MHz to 800 MHz
Radiated RF IEC 61000-4-3	3 V/m 80 MHz to 2.5 GHz	3 V/m 80 MHz to 2.5 GHz	$d = 1.2 \sqrt{P}$ 80 MHz to 800 MHz $d = 2.3 \sqrt{P}$ 800 MHz to 2.5 GHz  Where P is the maximum output power rating of the transmitter in watts (W) according to the transmitter manufacturer and d is the recommended separation distance in meters (m).  Field strengths from fixed RF transmitters, as determined by an electromagnetic site survey <sup>a</sup> , should be less than the compliance level in each frequency range. <sup>b</sup>  Interference may occur in the vicinity of equipment marked with the following symbol.  
Note 1: At 80 MHz and 800 MHz, the higher frequency range applies. Note 2: These guidelines may not apply in all situations. Electromagnetic propagation is affected by absorption and reflection from structures, objects and people.			
<sup>a</sup> Field strengths from fixed transmitters, such as base stations for radio (cellular/cordless) telephone and land mobile radios, amateur radio, AM and FM radio broadcast and TV broadcast cannot be predicted theoretically with accuracy. To assess the electromagnetic environment due to fixed RF transmitters, an electromagnetic site survey should be considered. If the measured field strength in the location in which the AEM Monitor and accessories is used exceeds the applicable RF compliance level above, the equipment should be observed to verify to normal operation. If abnormal performance is observed, additional measures may be necessary, such as reorienting or relocating the equipment. <sup>b</sup> Over the frequency range 150 kHz to 80 MHz, the field strengths should be less than 3 Vm.			

Recommended separation distances between portable and mobile RF communications equipment and the Model EM2 series AEM Monitor and accessories (EN 60601-1-2:2002 Table 206)			
The Model EM2 series AEM Monitor and accessories are intended for use in an electromagnetic environment in which radiated RF disturbances are controlled. The user of the Model EM2 series AEM Monitor and accessories can help prevent electromagnetic interference by maintaining a minimum distance between portable and mobile RF communications equipment (transmitters) and the Model EM2 series AEM Monitor and accessories as recommended below, according to the maximum output power of the of the communications equipment.			
Rated maximum output power of transmitter  W	Separation distance according to frequency of transmitter m		
	150 kHz to 80 MHz  $D = 1.2 \sqrt{P}$	80 MHz to 800 MHz  $D = 1.2 \sqrt{P}$	800 MHz to 2.5 GHz  $D = 2.3 \sqrt{P}$
0.01	0.12	0.12	0.23
0.1	0.38	0.38	0.73
1	1.2	1.2	2.3
10	3.8	3.8	7.3
100	12	12	23
For transmitters rated at a maximum out put power not listed above, the recommended distance d in meters (m) can be estimated using the equation applicable to the frequency of the transmitter, where P is the maximum output power rating of the transmitter in watts (W) according to the transmitter manufacturer. Note 1: At 80 MHz and 800 MHz, the separation distance for the higher frequency range applies. Note 2: These guidelines may not apply in all situations. Electromagnetic propagation is affected by absorption and reflection from structures, objects and people.			

Essential Performance confirmed by electromagnetic immunity testing:

- Shield function
- Detection of insulation breakdown and signal to ESU if threshold is reached
- Proper setup sequence, including detection of REM™ pad
- The AEM Monitor provides visual and audible indication of bipolar current (not likely to be affected by the adapter)



### Compatible Products

---

For successful operation, the AEM Monitor must be used with a set of compatible products. This includes: an electrosurgical generator with contact quality monitor, a return electrode, an active electrode, active cable, and trocar cannula.

### Electrosurgical Generator

---

The AEM Monitoring System is designed to work with the following electrosurgical generator in monopolar mode. Each is equipped with a contact quality monitoring circuit for the return electrode.

Electrosurgical Generator ConMed ARM™ equipped 115 V models	EM2AB
6400 <sup>1</sup>	Use ES9005 AEM Cord Adapter, with ES9007 Extender Adapter, or ES9015 <sup>2</sup> Universal Adapter
System 7550	Use ES9005 AEM Cord Adapter with ES9008 Extender, or ES9015 Universal Adapter Note: When using ES9015 Universal Adapter, contact Encision Technical Support at 800-988-0986 for monitor compatibility requirements.

<sup>1</sup> Not tested with 45cm instruments

<sup>2</sup> ES9015 Universal Adapter is for connecting AEM Hand Controlled and Foot Controlled Instruments to the AEM Monitor and ESU.

---

### Notice

---

ALL ELECTROSURGICAL GENERATORS (ESUs) MUST HAVE CONTACT QUALITY MONITORING CIRCUIT FOR RETURN ELECTRODES.

CORD ADAPTER: ES9015 IS FOR HAND AND FOOT CONTROLLED INSTRUMENTS; ES9005/ES9005A IS FOR FOOT CONTROLLED ONLY.

### Return Electrodes

---

The AEM Monitoring System requires a dual-area return electrode. The following products are designed to be used with electrosurgical generators having contact quality monitoring systems, such as ConMed/Aspen, 3M, NDM, Covidien/Valleylab, and others.

### Active Electrodes

---

---

#### Notice

---

SUCTION IRRIGATION ELECTRODES ARE RATED FOR USE WITH MAXIMUM ESU OUTPUT OF 60W.

The AEM Monitor must be used with instruments with patented AEM technology:

- manufactured by or for Encision Inc., or
- licensed by Encision Inc.

---

## 8 Replacement Procedures

---

This section gives instructions on replacing a specific part of your AEM Monitor. For your reference, a physical layout and electrical interconnect diagram that illustrates the placement of parts and all cable connections is provided on page 10-2.

### Warning

ELECTRIC SHOCK HAZARD. DISCONNECT THE POWER CORD BEFORE REPLACING PARTS.

### Caution

THE AEM MONITOR CONTAINS ELECTROSTATIC-SENSITIVE COMPONENTS. WHEN REPAIRING A UNIT, WORK AT A STATIC-CONTROL WORKSTATION AND WEAR A GROUNDING STRAP. HANDLE CIRCUIT BOARDS BY THEIR NONCONDUCTIVE EDGES. USE AN ANTISTATIC CONTAINER FOR TRANSPORT OF REPLACEMENT PARTS.

---

### Notice

---

BEFORE ANY OF THE FOLLOWING CAN BE PERFORMED, THE COVER MUST BE REMOVED.

### Removal of Cover

---

1. Turn off the AEM Monitor and disconnect the power cord from the wall receptacle.
2. Remove the six screws that secure the cover to the chassis. Save for reinstallation.
3. Lift the cover off the chassis. Save for reinstallation.

### D.C. Power Cable Replacement

---

1. Remove the D.C. power cable connectors from the ESM Main Board's J4 and the three output power supply's J2.
2. Install a new D.C. power cable by connecting it to the ESM Main Board's J4 and the three output power supply's J2.

### I/F Cable Replacement

---

1. Remove the I/F Cable connectors from the ESM Main Board's J5 and the EPM Main Board's J4.
2. Install the new I/F Cable by connecting it to the ESM Main Board's J5 and the EPM Main Board's J4.

### Three Output Power Supply

---

1. Disconnect all cable connections to the power supply: J1 and J2.
2. Remove the screws in the upper corners of the board. Save for reinstallation.
3. Pull up at each of the remaining corners of the board to free it from the standoff. (Apply force as close as possible to standoff to prevent breaking the corner of the board).
4. Put the power supply into an antistatic bag and return to the Encision Service Center.
5. Remove the new power supply board from the antistatic bag and orient it over the standoffs so that J1 is up.
6. Starting in the lower left corner, press the board onto the standoff until it snaps into place. (Apply force as close as possible to standoff to prevent breaking the corner of the board.)
7. Press the board onto the lower right standoff until it snaps into place. (Apply force as close as possible to standoff to prevent breaking the corner of the board.)
8. Reinstall the screws in the upper corners of the board.
9. Reconnect all cable connections to the power supply: J1 and J2.
10. Reconnect ground lug to screw in lower left corner.
11. Check the power supply's output voltages at power supply's J2:

Pins 2 and 4 are ground;  
Pin 1, + 15.0  $\pm$ .1V;  
Pin 3, +5.27  $\pm$ .05V;  
Pin 5, -15.0  $\pm$  .1V.

If any voltage is incorrect, adjust or replace the power supply.

### Front Panel Replacement

---

1. Disconnect the front panel cables connected to J1 and J2 on the EPM Main Board.
2. Disconnect the front panel cables connected to J1 and J2 on the ESM Main Board.
3. Remove the nuts and lock washers located at the left and right ends of the front panel, shown by arrows 1 & 2 on page 10-2. Save for reinstallation.
4. Remove the screw and lock washer which holds the front panel bracket to the chassis, shown by arrow 3 in on page 10-2. Save for reinstallation.
5. Slide the front panel assembly forward until the studs at the ends of the panel clear the chassis.
6. Put the front panel into an antistatic bag and return to the Encision Service Center.

7. Remove the new front panel from its antistatic bag and orient it in front of the chassis so that the printing is right side up.
8. Slide the studs at each end of the front panel into the corresponding holes of the chassis. Line up the hole in the front panel bracket with the tapped hole in the PCB mounting bracket.
9. Reinstall the screw and lock washer which holds the front panel bracket to the PCB mounting bracket, shown by arrow 3 on page 10-2. Tighten until snug.
10. Reinstall the lock washers and nuts (respectively) located at the left and right ends of the front panel, shown by arrows 1 & 2 on page 10-2.
11. Reconnect the front panel cables connected to J1 and J2 on the EPM Main Board.
12. Reconnect the front panel cables connected to J1 and J2 on the ESM Main Board.

### Reinstall Cover

---

1. Repeat the tests that failed. Proceed only if all tests pass.
2. Slide cover over the chassis. Line up the holes in the cover with the tapped holes in the chassis.
3. Install the five screws, previously removed, that secure the cover to the chassis. Tighten until snug.
4. Test the unit per instructions.
5. Unit is ready for use.

### Fuse Replacement

---

(NOTE: FUSE REPLACEMENT PROCEDURE IS ONLY FOR EXTERNAL FUSES. DO NOT REPLACE INTERNAL FUSES ON POWER SUPPLY. IF FUSES ARE BLOWN, REPLACE THE POWER SUPPLY OR SEND THE UNIT IN FOR REPAIR.)

1. Release the fuse drawer by inserting a screwdriver into the slot on top of the fuse drawer and pulling gently on the drawer. Slide the drawer out.
2. Remove the blown fuse from the drawer.
3. Replace the blown fuse with one of the same type and rating.
4. Slide the fuse drawer into its slot until it snaps into place.

## Replacement Procedures

---

### Inhibit Adapter Replacement

---

1. Remove cover from the AEM Monitor.
2. With a knife or small screwdriver push the metal part of the contacts down on the white connector. You will need to push the contact towards the wire while pushing down. Pull the wire after you have pushed the contact back. The contact should pull out of the connector. Look at the metal contact while removing; you will need to know the correct orientation of the contact to put the new one into place.
3. Insert the inhibit adapter cable from the new inhibit adapter through the hole in the front panel. You may need a pair of pliers to pull the cable through. Only pull on the strain portion of the cable. (Note: It may help to squeeze the strain relief and hold it. This will compress the material and make it easier to pull through the front panel. Also, the use of alcohol on the strain relief will help.)
4. Insert the metal contacts into the white connector in the correct location. Gently pull the wires after all of the contacts have been inserted into the connector to insure they are locked into position.
5. Attach white connector to PC board.
6. Reattach cover onto top of unit.

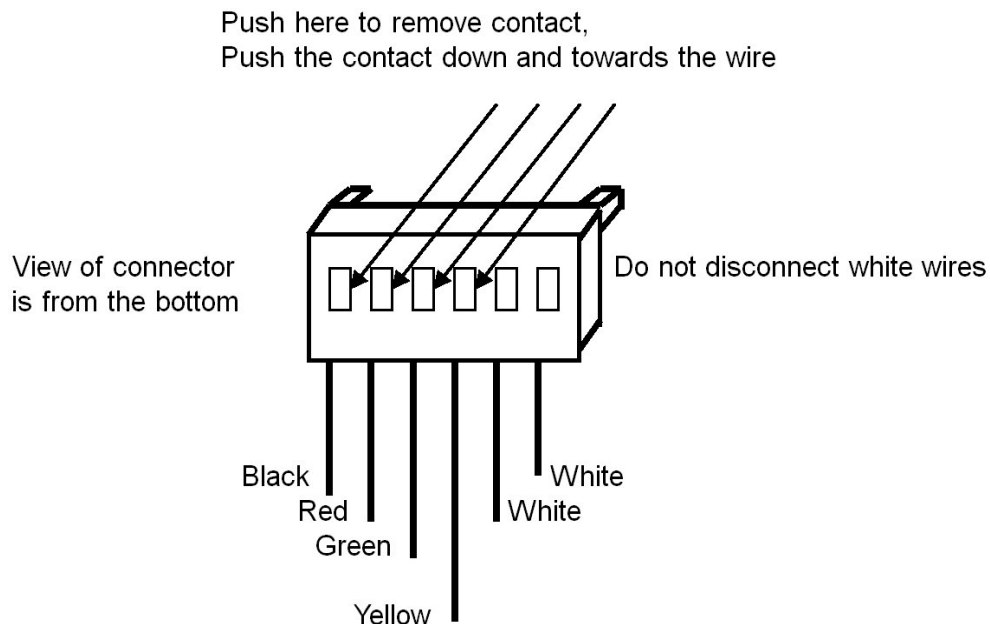

Perform AEM Monitor functions properly per section 3 of the AEM Monitor Operator/Service Manual.

Perform Normal Electrical Safety Tests as required per your Hospital's Protocol.

## 9 Repair Policy & Procedure

---

### Obtaining a Return Authorization Number

---

Before you return the AEM Monitor, front panel or power supply to Encision, call the Encision Customer Service Center to obtain a Return Authorization Number or call your Encision Representative for assistance.

Have the following Information ready when you call:

- hospital / clinic name / customer number
- telephone number
- department / address, city, state, and zip code
- model number
- serial number
- description of the problem
- type of repair to be done

### Returning the Monitor for Service

---

If you are returning the monitor for service, clean the monitor, then ship it to the Encision Service Center.

### Cleaning

---

1. Follow the procedures approved by your institution or use a validated infection control procedure.
2. Use a mild cleaning solution or disinfectant and a damp cloth to thoroughly wipe all outside surfaces and the power cord.

### Notice

---

DO NOT ALLOW FLUIDS TO ENTER THE CHASSIS.

DO NOT CLEAN THE AEM MONITOR WITH ABRASIVE CLEANING OR DISINFECTANT COMPOUNDS, SOLVENTS, OR OTHER MATERIALS THAT COULD SCRATCH THE PANELS OR DAMAGE THE UNIT.

DO NOT STEAM STERILIZE THE AEM MONITOR.

**Shipping the Monitor**

---

- Be sure the monitor is completely dry before you pack it for shipment. Package the monitor in its original shipping container, if available.
- Ship the monitor prepaid to the Encision Service Center.

**Service Center**

---

Encision Inc.  
6797 Winchester Circle  
Boulder, Colorado, 80301-3513 USA

(303) 444-2600

[www.encision.com](http://www.encision.com)

## Limited Warranty

---

**Express Warranty:** ENCISION hereby warrants to Buyer that products purchased hereunder shall be free from defects in material and workmanship under normal use and service, as specified in ENCISION's product manuals and Instructions for Use provided with such product, for the period of:

- AEM Monitors – one (1) year from date of shipment to Buyer, or ninety (90) days from the date of shipment to Buyer of any repair, reconditioning or replacement thereof, whichever is longer.
- Instruments and Accessories – as stated in the applicable Instructions for Use. This warranty shall run in favor of Buyer only, and is not enforceable by any other person or entity.

**Disclaimer:** THE EXPRESS WARRANTIES SET FORTH IN THIS AGREEMENT ARE IN LIEU OF, AND BUYER HEREBY EXPRESSLY WAIVES, ALL OTHER GUARANTEES AND WARRANTIES OF ANY KIND, WHETHER EXPRESS, IMPLIED OR STATUTORY INCLUDING, WITHOUT LIMITATION, MERCHANTABILITY, FITNESS FOR PARTICULAR PURPOSE, NON-INFRINGEMENT OR BY SAMPLE, AND ALL SUCH OTHER WARRANTIES ARE HEREBY DISCLAIMED AND EXCLUDED BY ENCISION. THE SOLE AND EXCLUSIVE REMEDY FOR BREACH OF ENCISION'S WARRANTY OF THE PRODUCTS SHALL BE AS STATED HEREIN.

**Exclusions:** The express warranty set forth above specifically excludes and does not apply to defects (i) caused through no fault of ENCISION during shipment to or from Buyer, (ii) caused by modifications or alterations made to the products by Buyer or any third party (iii) caused by unauthorized repair or maintenance performed on the products by Buyer or any third party, (iv) caused by the failure of Buyer to comply with any of the return procedures specified below, or (v) damaged by excessive current, temperature, physical stress or other deviation from the applicable environmental specifications.

**Limitation of Remedies:** ENCISION's sole obligation and Buyer's exclusive remedy for any breach of warranty is limited to the repair or replacement, at Encision's option, of any warranted product that is returned to ENCISION in its standard shipping container or properly packed in accordance with ENCISION's packing procedures, freight prepaid, where ENCISION's examination shows the product to have failed under normal use. If ENCISION's examination discloses that the returned product is not defective within the terms of this warranty, Buyer shall be subject to a \$200.00 charge per individual product for testing expenses incurred by ENCISION and the product will be returned to Buyer, freight collect. Such repair or replacement and reshipment at ENCISION's expense will be Buyer's sole and exclusive remedy for such defect. ENCISION will pay shipping charges for the repaired or replaced from ENCISION's factory to Buyer's location. If, notwithstanding the foregoing, Buyer ships any product to ENCISION's factory freight collect, then ENCISION shall ship the repaired or replaced product freight collect.



## Repair Policy and Procedures

---

**Warranty Procedures:** Buyer shall request authorization from ENCISION prior to the return of each defective product for repair or replacement by ENCISION. Upon such request, ENCISION shall provide the address of the facility to which such product must be returned, together with Return Material Authorization (RMA) tracer number. ENCISION may, at its sole option, employ new or used parts for products to make such repair or replacement.

**Stored Data:** ENCISION shall not be liable for any loss or damage to any data stored in any product, including, without limitation, any data loss or damage resulting from any malfunction or defect or any loss or damage resulting from any inspection, repair, refurbishment, reconditioning or testing of the product or incurred in connection with transportation of the product to ENCISION or ENCISION's authorized repair center.

**Technical Assistance:** ENCISION's warranty shall not be enlarged, and no obligation or liability shall arise out of ENCISION's rendering of technical advice or assistance in connection with the products sold hereunder.

**Limitation of Liability:** TO THE EXTENT ALLOWABLE BY APPLICABLE LAW, IN NO EVENT SHALL ENCISION BE LIABLE FOR ANY SPECIAL, INCIDENTAL OR CONSEQUENTIAL DAMAGES IN CONNECTION WITH OR ARISING OUT OF THE SALE, INSTALLATION, USE, OPERATION, SERVICE OR REPAIR OF ANY PRODUCT, WHETHER BASED ON BREACH OF WARRANTY OR CONTRACT, STRICT LIABILITY, NEGLIGENCE OR OTHERWISE, WHETHER OR NOT ENCISION SHALL HAVE BEEN ADVISED AS TO THE POSSIBILITY OR REASON FOR ANY SUCH POTENTIAL LOSS OR DAMAGE. DIRECT DAMAGES SHALL BE STRICTLY LIMITED TO THE COST TO BUYER OF THE PRODUCTS SOLD OR PROVIDED TO BUYER, NOT WITHSTANDING ANY FAILURE OF ESSENTIAL PURPOSE OF ANY LIMITED REMEDY.

---

## 10 Service Parts

---

Replacement parts for the AEM Monitor are listed in this section. If a part is not listed, it is not available.

For schematics or replacement part information, please contact the Encision Service Center (303-444-2600).

A.C. Power Cord, 115V	00492-000
D.C. Power Cable	00483-001
Front Panel	00638-005
Fuse, 5 x 20 mm, 0.5 Amp (115V)	01331-000
I/F Cable	00484-000
Inhibit Adapter Assembly, 21" w/o Extension	00652-002
Power Supply, Three Output	01347-000
Shield Connector Assembly	01452-000
Bipolar Cord (115v)	ES9004
Inhibit Adapter Extension	ES9009

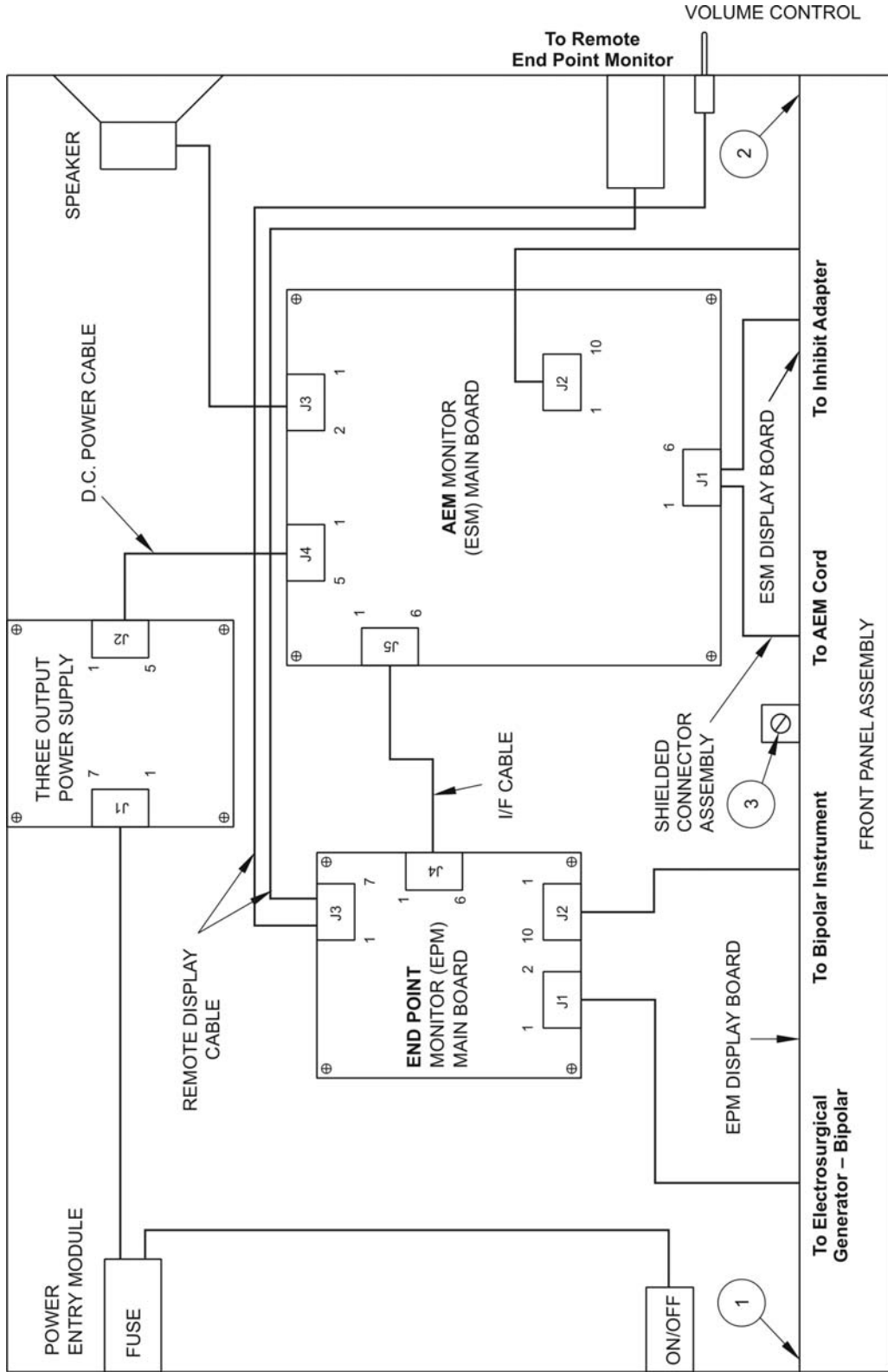

Block Diagram – AEM Monitor